

Closed-coupled Pump

Etabloc

Installation/Operating Manual



Legal information/Copyright

Installation/Operating Manual Etabloc

Original operating manual

All rights reserved. The contents provided herein must neither be distributed, copied, reproduced, edited or processed for any other purpose, nor otherwise transmitted, published or made available to a third party without the manufacturer's express written consent.

Subject to technical modification without prior notice.

© KSB SE & Co. KGaA, Frankenthal 15/04/2020

Contents

Glossary	5
1 General	6
1.1 Principles	6
1.2 Installation of partly completed machinery.....	6
1.3 Target group.....	6
1.4 Other applicable documents.....	6
1.5 Symbols	6
1.6 Key to safety symbols/markings.....	7
2 Safety	8
2.1 General.....	8
2.2 Intended use	8
2.3 Personnel qualification and training.....	8
2.4 Consequences and risks caused by non-compliance with this manual	9
2.5 Safety awareness	9
2.6 Safety information for the operator/user	9
2.7 Safety information for maintenance, inspection and installation	9
2.8 Unauthorised modes of operation	10
2.9 Explosion protection	10
2.9.1 Marking	10
2.9.2 Temperature limits.....	10
2.9.3 Monitoring equipment.....	11
2.9.4 Operating limits	11
3 Transport/Storage/Disposal	12
3.1 Checking the condition upon delivery	12
3.2 Transport.....	12
3.3 Storage/preservation	13
3.4 Return to supplier.....	13
3.5 Disposal	14
4 Description of the Pump (Set)	15
4.1 General description	15
4.2 Product Information as per Regulation No. 547/2012 (for water pumps with a maximum shaft power of 150 kW) implementing "Ecodesign" Directive 2009/125/EC.....	15
4.3 Designation.....	15
4.4 Name plate.....	18
4.5 Design details.....	18
4.6 Installation types	20
4.7 Configuration and function.....	22
4.8 Noise characteristics	23
4.9 Scope of supply.....	23
4.10 Dimensions and weights	23
5 Installation at Site	24
5.1 Checking the site before installation	24
5.2 Installing the pump set	24
5.3 Piping	25
5.3.1 Connecting the piping.....	25
5.3.2 Permissible forces and moments at the pump nozzles.....	27
5.3.3 Vacuum balance line.....	29
5.3.4 Auxiliary connections.....	30
5.4 Enclosure/insulation	31
5.5 Electrical connection	31
5.5.1 Setting the time relay	32
5.5.2 Earthing.....	32

5.5.3	Connecting the motor	32
5.6	Checking the direction of rotation.....	32
6	Commissioning/Start-up/Shutdown.....	34
6.1	Commissioning/Start-up.....	34
6.1.1	Prerequisites for commissioning/start-up	34
6.1.2	Priming and venting the pump.....	34
6.1.3	Start-up.....	35
6.1.4	Checking the shaft seal.....	36
6.1.5	Shutdown	36
6.2	Operating limits.....	37
6.2.1	Ambient temperature.....	37
6.2.2	Frequency of starts.....	37
6.2.3	Fluid handled	38
6.3	Shutdown/storage/preservation	39
6.3.1	Measures to be taken for shutdown	39
6.4	Returning to service	39
7	Servicing/Maintenance.....	41
7.1	Safety regulations.....	41
7.2	Servicing/Inspection.....	42
7.2.1	Supervision of operation	42
7.2.2	Inspection work.....	44
7.3	Drainage/cleaning	45
7.4	Dismantling the pump set.....	45
7.4.1	General information/Safety regulations.....	45
7.4.2	Preparing the pump set.....	46
7.4.3	Dismantling the complete pump set	46
7.4.4	Removing the motor.....	46
7.4.5	Removing the back pull-out unit	47
7.4.6	Removing the impeller	47
7.4.7	Removing the mechanical seal.....	47
7.5	Reassembling the pump set.....	48
7.5.1	General information/Safety regulations.....	48
7.5.2	Installing the mechanical seal	49
7.5.3	Fitting the impeller.....	50
7.5.4	Installing the back pull-out unit	50
7.5.5	Mounting the motor.....	50
7.6	Tightening torques.....	52
7.7	Spare parts stock.....	53
7.7.1	Ordering spare parts.....	53
7.7.2	Recommended spare parts stock	53
8	Trouble-shooting.....	55
9	Related Documents	57
9.1	General assembly drawings	57
9.1.1	Pump set with single mechanical seal and bolted casing cover.....	57
9.1.2	Pump set with single mechanical seal and clamped casing cover	59
9.1.3	Version with double mechanical seal in back-to-back arrangement	61
9.1.4	Version with double mechanical seal in tandem arrangement.....	62
10	EU Declaration of Conformity	63
11	Certificate of Decontamination.....	64
	Index	65

Glossary

ACS

French drinking water regulations (ACS = Attestation de Conformité Sanitaire)

Back pull-out unit

Pump without pump casing; partly completed machinery

Certificate of decontamination

A certificate of decontamination is enclosed by the customer when returning the product to the manufacturer to certify that the product has been properly drained to eliminate any environmental and health hazards arising from components in contact with the fluid handled.

Discharge line

The pipeline which is connected to the discharge nozzle

Hydraulic system

The part of the pump in which the kinetic energy is converted into pressure energy

IE3

Efficiency class to IEC 60034-30: 3 = Premium Efficiency (IE = International Efficiency)

Pool of pumps

Customers/operators' pumps which are purchased and stored regardless of their later use.

Pump

Machine without drive, additional components or accessories

Pump set

Complete pump set consisting of pump, drive, additional components and accessories

Suction lift line/suction head line

The pipeline which is connected to the suction nozzle

UBA

German drinking water regulations to German Environment Agency

WRAS

Approved by all water suppliers in the UK (WRAS = Water Regulations Advisory Scheme)

1 General

1.1 Principles

This operating manual is valid for the type series and variants indicated on the front cover.

The operating manual describes the proper and safe use of this equipment in all phases of operation.

The name plate indicates the type series and size, the main operating data, the order number and the order item number. The order number and order item number clearly identify the pump set and serve as identification for all further business processes.

In the event of damage, immediately contact your nearest KSB service facility to maintain the right to claim under warranty.

1.2 Installation of partly completed machinery

To install partly completed machinery supplied by KSB refer to the sub-sections under Servicing/Maintenance.

1.3 Target group

This operating manual is aimed at the target group of trained and qualified specialist technical personnel. (⇒ Section 2.3, Page 8)

1.4 Other applicable documents

Table 1: Overview of other applicable documents

Document	Contents
Data sheet	Description of the technical data of the pump (set)
General arrangement drawing/ outline drawing	Description of mating and installation dimensions for the pump (set), weights
Drawing of auxiliary connections	Description of auxiliary connections
Hydraulic characteristic curve	Characteristic curves showing head, NPSH required, efficiency and power input
General assembly drawing ¹⁾	Sectional drawing of the pump
Sub-supplier product literature ¹⁾	Operating manuals and other documentation for accessories and integrated machine parts
Spare parts lists ¹⁾	Description of spare parts
Piping layout ¹⁾	Description of auxiliary piping
List of components ¹⁾	Description of all pump components
Drawing for assembly ¹⁾	Sectional drawing of the installed shaft seal

For accessories and/or integrated machinery components observe the relevant manufacturer's product literature.

1.5 Symbols

Table 2: Symbols used in this manual







Symbol	Description
✓	Conditions which need to be fulfilled before proceeding with the step-by-step instructions
▷	Safety instructions
⇨	Result of an action
⇔	Cross-references

1) If agreed upon in scope of supply

Symbol	Description
1. 2.	Step-by-step instructions
	Note Recommendations and important information on how to handle the product

1.6 Key to safety symbols/markings

Table 3: Definition of safety symbols/markings

Symbol	Description
 DANGER	DANGER This signal word indicates a high-risk hazard which, if not avoided, will result in death or serious injury.
 WARNING	WARNING This signal word indicates a medium-risk hazard which, if not avoided, could result in death or serious injury.
CAUTION	CAUTION This signal word indicates a hazard which, if not avoided, could result in damage to the machine and its functions.
	Explosion protection This symbol identifies information about avoiding explosions in potentially explosive atmospheres in accordance with EU Directive 2014/34/EU (ATEX).
	General hazard In conjunction with one of the signal words this symbol indicates a hazard which will or could result in death or serious injury.
	Electrical hazard In conjunction with one of the signal words this symbol indicates a hazard involving electrical voltage and identifies information about protection against electrical voltage.
	Machine damage In conjunction with the signal word CAUTION this symbol indicates a hazard for the machine and its functions.



2 Safety

All the information contained in this section refers to hazardous situations.

In addition to the present general safety information the action-related safety information given in the other sections must be observed.

2.1 General

- This operating manual contains general installation, operating and maintenance instructions that must be observed to ensure safe operation of the system and prevent personal injury and damage to property.
- Comply with all the safety instructions given in the individual sections of this operating manual.
- The operating manual must be read and understood by the responsible specialist personnel/operators prior to installation and commissioning.
- The contents of this operating manual must be available to the specialist personnel at the site at all times.
- Information and markings attached directly to the product must always be complied with and kept in a perfectly legible condition at all times. This applies to, for example:
 - Arrow indicating the direction of rotation
 - Markings for connections
 - Name plate
- The operator is responsible for ensuring compliance with all local regulations not taken into account.

2.2 Intended use

- The pump (set) must only be operated in the fields of application and within the use limits specified in the other applicable documents.
- Only operate pumps/pump sets which are in perfect technical condition.
- Do not operate the pump (set) in partially assembled condition.
- Only use the pump (set) to handle the fluids described in the data sheet or product literature of the pump model.
- Never operate the pump (set) without the fluid to be handled.
- Observe the minimum flow rate and maximum flow rate indicated in the data sheet or product literature (to prevent overheating, mechanical seal damage, cavitation damage, bearing damage, etc.).
- Always operate the pump (set) in the direction of rotation it is intended for.
- Do not throttle the flow rate on the suction side of the pump (to prevent cavitation damage).
- Consult the manufacturer about any use or mode of operation not described in the data sheet or product literature.

2.3 Personnel qualification and training

All personnel involved must be fully qualified to transport, install, operate, maintain and inspect the machinery this manual refers to.

The responsibilities, competence and supervision of all personnel involved in transport, installation, operation, maintenance and inspection must be clearly defined by the operator.

Deficits in knowledge must be rectified by means of training and instruction provided by sufficiently trained specialist personnel. If required, the operator can commission the manufacturer/supplier to train the personnel.

Training on the pump (set) must always be supervised by technical specialist personnel.

2.4 Consequences and risks caused by non-compliance with this manual

- Non-compliance with these operating instructions will lead to forfeiture of warranty cover and of any and all rights to claims for damages.
- Non-compliance can, for example, have the following consequences:
 - Hazards to persons due to electrical, thermal, mechanical and chemical effects and explosions
 - Failure of important product functions
 - Failure of prescribed maintenance and servicing practices
 - Hazard to the environment due to leakage of hazardous substances

2.5 Safety awareness

In addition to the safety information contained in this operating manual and the intended use, the following safety regulations shall be complied with:

- Accident prevention, health regulations and safety regulations
- Explosion protection regulations
- Safety regulations for handling hazardous substances
- Applicable standards, directives and laws

2.6 Safety information for the operator/user

- Fit protective equipment (e.g. contact guards) supplied by the operator for hot, cold or moving parts, and check that the equipment functions properly.
- Do not remove any protective equipment (e.g. contact guards) during operation.
- Provide the personnel with protective equipment and make sure it is used.
- Contain leakages (e.g. at the shaft seal) of hazardous fluids handled (e.g. explosive, toxic, hot) so as to avoid any danger to persons and the environment. Adhere to all relevant laws.
- Eliminate all electrical hazards. (In this respect refer to the applicable national safety regulations and/or regulations issued by the local energy supply companies.)
- If shutting down the pump does not increase potential risk, fit an emergency-stop control device in the immediate vicinity of the pump (set) during pump set installation.

2.7 Safety information for maintenance, inspection and installation

- Modifications or alterations of the pump (set) are only permitted with the manufacturer's prior consent.
- Use only original spare parts or parts/components authorised by the manufacturer. The use of other parts/components can invalidate any liability of the manufacturer for resulting damage.
- The operator ensures that maintenance, inspection and installation are performed by authorised, qualified specialist personnel who are thoroughly familiar with the manual.
- Only carry out work on the pump (set) during standstill of the pump.
- Only perform work on the pump set when it has been disconnected from the power supply (de-energised).
- The pump (set) must have cooled down to ambient temperature.
- Pump pressure must have been released and the pump must have been drained.

- When taking the pump set out of service always adhere to the procedure described in the manual. (⇒ Section 6.1.5, Page 36) (⇒ Section 6.3, Page 39)
- Decontaminate pumps which handle fluids posing a health hazard.
- As soon as the work has been completed, re-install and re-activate any safety-relevant devices and protective devices. Before returning the product to service, observe all instructions on commissioning. (⇒ Section 6.1, Page 34)

2.8 Unauthorised modes of operation

Never operate the pump (set) outside the limits stated in the data sheet and in this manual.

The warranty relating to the operating reliability and safety of the supplied pump (set) is only valid if the equipment is used in accordance with its intended use. (⇒ Section 2.2, Page 8)

2.9 Explosion protection



Always observe the information on explosion protection given in this section when operating the product in potentially explosive atmospheres.

Only pumps/pump sets marked as explosion-proof **and** identified as such in the data sheet may be used in potentially explosive atmospheres.

Special conditions apply to the operation of explosion-proof pump sets to EU Directive 2014/34/EU (ATEX).

Especially adhere to the sections in this manual marked with the symbol opposite and the following sections, (⇒ Section 2.9.1, Page 10) to (⇒ Section 2.9.4, Page 11) The explosion-proof status of the pump set is only assured if the pump set is used in accordance with its intended use.

Never operate the pump set outside the limits stated in the data sheet and on the name plate.

Prevent impermissible modes of operation at all times.

2.9.1 Marking

Pump The marking on the pump refers to the pump part only.

Example of such marking:
II 2G Ex h IIC T5-T1 Gb

Refer to the individual Temperature Limits table for the temperatures permitted for the individual pump variants. (⇒ Section 2.9.2, Page 10)

The pump complies with the requirements of type of protection constructional safety "c" to ISO 80079-37.

Shaft coupling An EC manufacturer's declaration is required for the shaft coupling; the shaft coupling must be marked accordingly.

Motor The motor has its own marking. The marking is maintained on the condition that the temperatures the pump causes to develop at the motor flange and motor shaft are permitted by the motor manufacturer.

The motors used by KSB on pumps with ATEX certification meet this condition.

Misuse, malfunctions or non-compliance with the instructions may result in substantially higher temperatures.

2.9.2 Temperature limits

In normal pump operation, the highest temperatures are to be expected on the surface of the pump casing and at the shaft seal.

The surface temperature at the pump casing corresponds to the temperature of the fluid handled. If the pump is heated in addition, the operator of the system is responsible for observing the specified temperature class and fluid temperature (operating temperature).

The table below lists the temperature classes and the resulting theoretical temperature limits of the fluid handled (a potential temperature rise in the shaft seal area has been taken into account).

The temperature class specifies the maximum permissible temperature at the surface of the pump set during operation. For the permissible operating temperature of the pump in question refer to the data sheet.

Table 4: Temperature limits

Temperature class to ISO 80079-36	Maximum permissible fluid temperature
T1	Temperature limit of the pump
T2	280 °C
T3	185 °C
T4	120 °C
T5	85 °C
T6	Only after consultation with the manufacturer

If the pump is to be operated at a higher temperature, the data sheet is missing or if the pump is part of a pool of pumps, contact KSB for the maximum permissible operating temperature.

Motor supplied by the operator

If a pump is supplied without motor (as part of a pool of pumps), the motor specified in the pump data sheet must meet the following conditions:

- The permissible temperature limits at the motor flange and motor shaft must be higher than the temperatures generated by the pump.
- Contact the manufacturer for the actual pump temperatures.

2.9.3 Monitoring equipment

The pump (set) must only be operated within the limits specified in the data sheet and on the name plate.

If the system operator cannot warrant compliance with these operating limits, appropriate monitoring devices must be used.

Check whether monitoring equipment is required to ensure that the pump set functions properly.

Contact KSB for further information about monitoring equipment.

2.9.4 Operating limits

The minimum flow rates indicated in (⇒ Section 6.2.3.1, Page 38) refer to water and water-like fluids handled. Longer operating periods with these fluids and at the flow rates indicated will not cause an additional increase in the temperatures at the pump surface. However, if the physical properties of the fluids handled are different from water, it is essential to check whether an additional heat build-up may occur and if the minimum flow rate must therefore be increased. The calculation formula in (⇒ Section 6.2.3.1, Page 38) can be used to check whether additional heat build-up may lead to a dangerous temperature increase at the pump surface.

3 Transport/Storage/Disposal

3.1 Checking the condition upon delivery

1. On transfer of goods, check each packaging unit for damage.
2. In the event of in-transit damage, assess the exact damage, document it and notify KSB or the supplying dealer and the insurer about the damage in writing immediately.

3.2 Transport

	<p>! DANGER</p>
	<p>The pump (set) could slip out of the suspension arrangement Danger to life from falling parts!</p> <ul style="list-style-type: none"> ▷ Always transport the pump (set) in the specified position. ▷ Never attach the suspension arrangement to the free shaft end or the motor eyebolt. ▷ Observe the information about weights, centre of gravity and fastening points. ▷ Observe the applicable local accident prevention regulations. ▷ Use suitable, permitted lifting accessories, e.g. self-tightening lifting tongs.
	<p>CAUTION</p>
	<p>Incorrect transport of the pump Damage to the shaft seal!</p> <ul style="list-style-type: none"> ▷ For transport, lock the pump shaft with a suitable transport lock to prevent any movement of the shaft.

When transporting the pump without motor, shaft 210 must be locked.

1. Remove cover plates 68-3 from the openings of drive lantern 341.
2. Insert lock washers 931.95 into the shaft groove.
3. Tighten bolts 901.50.

To transport the pump/pump set suspend it from the lifting tackle as shown.

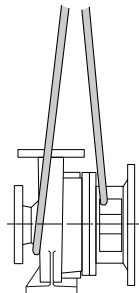

Fig. 1: Transporting the pump

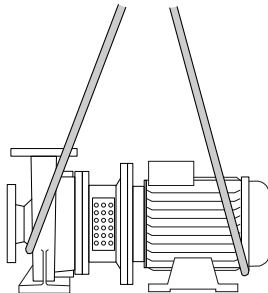

Fig. 2: Transporting the pump set

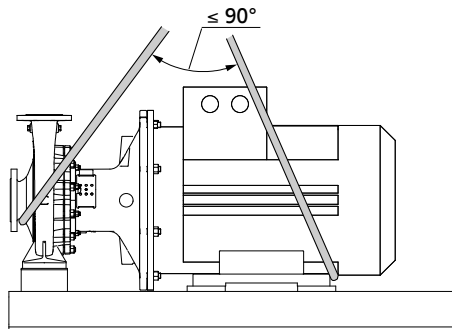

Fig. 3: Transporting the pump set on the baseplate

3.3 Storage/preservation

	<p>CAUTION</p>
	<p>Damage during storage due to humidity, dirt or vermin Corrosion/contamination of the pump (set)!</p> <ul style="list-style-type: none"> ▷ For outdoor storage cover the pump (set) or the packaged pump (set) and accessories with waterproof material.
	<p>CAUTION</p>
	<p>Wet, contaminated or damaged openings and connections Leakage or damage to the pump!</p> <ul style="list-style-type: none"> ▷ Clean and cover pump openings and connections as required prior to putting the pump into storage.

If commissioning is to take place some time after delivery, we recommend that the following measures be taken for pump (set) storage.

- Store the pump (set) in a dry, protected room where the atmospheric humidity is as constant as possible.
- Rotate the shaft by hand once a month, e.g. via the motor fan.

If properly stored indoors, the pump set is protected for a maximum of 12 months. New pumps/pump sets are supplied by our factory duly prepared for storage.



For storing a pump (set) which has already been operated, the shutdown measures must be adhered to. (⇒ Section 6.3.1, Page 39)

3.4 Return to supplier

1. Drain the pump as per operating instructions.
2. Flush and clean the pump, particularly if it has been used for handling noxious, explosive, hot or other hazardous fluids.
3. If the pump has handled fluids whose residues could lead to corrosion damage in the presence of atmospheric humidity or could ignite upon contact with oxygen also neutralise the pump and blow through with anhydrous inert gas to ensure drying.
4. Always complete and enclose a certificate of decontamination when returning the pump.
Indicate any safety measures and decontamination measures taken.
(⇒ Section 11, Page 64)

	<p>NOTE</p>
	<p>If required, a blank certificate of decontamination can be downloaded from the following web site: www.ksb.com/certificate_of_decontamination</p>

3.5 Disposal

	 WARNING
	<p>Fluids handled, consumables and supplies which are hot and/or pose a health hazard</p> <p>Hazard to persons and the environment!</p> <ul style="list-style-type: none"> ▶ Collect and properly dispose of flushing fluid and any fluid residues. ▶ Wear safety clothing and a protective mask if required. ▶ Observe all legal regulations on the disposal of fluids posing a health hazard.

1. Dismantle the pump (set).
Collect greases and other lubricants during dismantling.
2. Separate and sort the pump materials, e.g. by:
 - Metals
 - Plastics
 - Electronic waste
 - Greases and other lubricants
3. Dispose of materials in accordance with local regulations or in another controlled manner.

4 Description of the Pump (Set)

4.1 General description

- Centrifugal pump with shaft seal
- Close-coupled design
- Handling clean or aggressive fluids not chemically and mechanically aggressive to the pump materials.

4.2 Product Information as per Regulation No. 547/2012 (for water pumps with a maximum shaft power of 150 kW) implementing "Ecodesign" Directive 2009/125/EC

- Minimum efficiency index: see name plate, key to name plate
- The benchmark for the most efficient water pumps is $MEI \geq 0.70$.
- Year of construction: see name plate, key to name plate
- Manufacturer's name or trade mark, commercial registration number and place of manufacture: see data sheet or order documentation
- Product's type and size identifier: see name plate, key to name plate
- Hydraulic pump efficiency (%) with trimmed impeller: see data sheet
- Pump performance curves, including efficiency characteristics: see documented characteristic curve
- The efficiency of a pump with a trimmed impeller is usually lower than that of a pump with full impeller diameter. Trimming of the impeller will adapt the pump to a fixed duty point, leading to reduced energy consumption. The minimum efficiency index (MEI) is based on the full impeller diameter.
- Operation of this water pump with variable duty points may be more efficient and economic when controlled, for example, by the use of a variable speed drive that matches the pump duty to the system.
- Information on dismantling, recycling and disposal after decommissioning: (⇒ Section 3.5, Page 14)
- Information on benchmark efficiency or benchmark efficiency graph for $MEI = 0.70$ (0.40) for the pump based on the model shown in the Figure are available at: <http://www.europump.org/efficiencycharts>

4.3 Designation

Table 5: Designation example

Position																																					
1	2	3	4	5	6	7	8	9	10	11	12	13	14	15	16	17	18	19	20	21	22	23	24	25	26	27	28	29	30	31	32	33	34	35	36	37	38
E	T	B	-	0	4	0	-	0	2	5	-	1	6	0	-	G	G	S	A	V	6	7	D	2	1	1	0	0	2	-	-	B	P	D	2	E	M
See name plate and data sheet																										See data sheet						-					

Table 6: Designation key

Position	Code	Description
1-4	Pump type	
	ETB	Etabloc
	ETBF	Etabloc bottle rinser variant
5-16	Size [mm], e.g.	
	040	Nominal suction nozzle diameter
	025	Nominal discharge nozzle diameter
	160	Nominal impeller diameter
17	Pump casing material	
	B	Bronze
	C	Stainless steel
	G	Cast iron
		CC480K-GS / B30 C90700
		1.4408 / A743CF8M
		EN-GJL-250 / A48Cl.35B

Position	Code	Description	
17	S	Nodular cast iron	Nodular cast iron EN-GJS-400-15/A536 Gr 60-40-18
18	Impeller material		
	B	Bronze	CC480K-DW
	C	Stainless steel	1.4408 / A743CF8M
	G	Cast iron	EN-GJL-250 / A48Cl.35B
19	Design		
	E	EGV 1935/2004	
	F	Bottle rinser variant	
	H	Approved for drinking water to ACS	
	K	Approved for drinking water to KSB standard	
	P	Swimming pool variant	
	R	Gohl (special design)	
	S	Standard	
	U	Approved for drinking water to UBA	
	W	Approved for drinking water to WRAS	
X	Non-standard (BT3D, BT3)		
20	Casing cover		
	A	Conical seal chamber	
	C	Cylindrical seal chamber	
21	Shaft seal type		
	D	Double mechanical seal in back-to-back arrangement	
	E	Single mechanical seal, external circulation	
	F	Single mechanical seal, external flushing	
	I	Single mechanical seal, internal circulation, conical cover (A-type cover) only	
	S	Single mechanical seal with vented chamber (A-type cover), discharge cover with anti-swirl baffles	
	T	Double mechanical seal in tandem arrangement with internal circulation	
V	Single mechanical seal with vented chamber (A-type cover)		
22-23	Seal code, single mechanical seal		
	01	Q1Q1VGG	1 (ZN1181) $\geq -20 - \leq +110$ [°C]
	06	U3BEGG (shaft units 25, 35)	RMG13G606 $\geq -30 - \leq +140$ [°C]
	07	Q1Q1EGG	1 A (ZN1181) $\geq -30 - \leq +110$ [°C]
	08	AQ1VGG	M32N69 $\geq -30 - \leq +110$ [°C]
	09	U3U3VGG	MG13G60 $\geq -20 - \leq +110$ [°C]
	10	Q1Q1X4GG	1 (ZN1181) $\geq -20 - \leq +110$ [°C]
	11	BQ1EGG-WA (WA = drinking water)	1 (ZN1181) $\geq -30 - \leq +110$ [°C]
	12	Q12Q1M1GG1	M37GN83 $\geq -20 - \leq +100$ [°C]
	13	BQ1VGG	1 (ZN1181) $\geq -20 - \leq +110$ [°C]
	14	Q1Q1KY7G	KMB13S2G9 $\geq -20 - \leq +120$ [°C]
	15	Q1Q1KGG	M7G49 $\geq -20 - \leq +110$ [°C]
	16	BVPGG	MG1S20 $\geq -20 - \leq +110$ [°C]
	17	Q1BVGG	M7N $\geq -20 - \leq +110$ [°C]
	22	AQ1EGG (shaft unit 55)	M32N69 $\geq -30 - \leq +140$ [°C]
	66	Q7Q7EGG	MG13G6 $\geq -30 - \leq +120$ [°C]
	67	Q6Q6X4GG	MG13G60 / MG1G61S6 $\geq -20 - \leq +110$ [°C]
	Seal code, double mechanical seal in tandem arrangement		

Position	Code	Description			
22-23	18	Q1Q1EGG/G	MG12G6-E1	$\geq -30 - \leq +110$ [°C]	
		Q1Q1EGG-G	MG12G6-E1	$\geq -30 - \leq +110$ [°C]	
	19	Q1Q1M1GG	HN400N	$\geq -30 - \leq +110$ [°C]	
		Q1Q1EGG-G	MG12G6-E1	$\geq -30 - \leq +110$ [°C]	
	20	Q12Q1M1GG1	M37GN85	$\geq -20 - \leq +110$ [°C]	
		Q1Q1EGG-G	MG12G6-E1	$\geq -20 - \leq +110$ [°C]	
	23	Q12Q1M1GG1	M37GN92	$\geq -20 - \leq +110$ [°C]	
		Q1Q1EGG-G	MG12G6-E1	$\geq -20 - \leq +110$ [°C]	
	Seal code, double mechanical seal in back-to-back arrangement				
	21	Q1Q1KGG	M7G49	$\geq -20 - \leq +110$ [°C]	
		Q1Q1KGG	M7G49	$\geq -20 - \leq +110$ [°C]	
	24	Q1Q1KGG	M7G49	$\geq -20 - \leq +110$ [°C]	
		Q1BVGG	M7N	$\geq -20 - \leq +110$ [°C]	
	Seal code without mechanical seal				
99	Shaft seal ring, variant Gohl				
24	Scope of supply				
	A	Pump only (Fig. 0)			
	D	Pump, motor			
	G	Pump, baseplate			
	E	Pump, back pull-out unit			
25	Shaft unit				
	2	Shaft unit 25			
	3	Shaft unit 35			
	5	Shaft unit 55			
26-29	Motor rating P_N [kW]				
	0075	7,5			
	0300	30			
	1100	110			
30	Number of motor poles				
	2	2 poles			
	4	4 poles			
	6	6 poles			
31-32	Explosion protection				
	ex	With explosion-proof motor			
	--	Without explosion-proof motor			
33	Product generation				
	B	Etabloc			
34-37	Design				
	-	Fixed speed version			
	PD2	Variable speed version, with PumpDrive 2			
	PD2E	Variable speed version, with PumpDrive 2 Eco			
	IFS	MyFlow Drive			
38	PumpMeter				
	M	PumpMeter			

4.4 Name plate

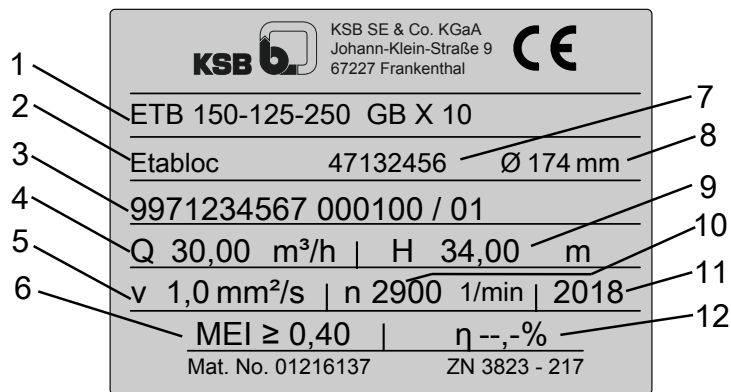

Fig. 4: Name plate (example)

1	Type series code, size and version	2	Type series
3	KSB order No., order item No. and consecutive No.	4	Flow rate
5	Kinematic viscosity of the fluid handled	6	Minimum efficiency index
7	Material number (if applicable)	8	Impeller diameter
9	Head	10	Speed
11	Year of construction	12	Efficiency (see data sheet)

4.5 Design details

Design

- Volute casing pump
- Single-stage
- Ratings to EN 733
- Requirements to 2009/125/EC Directive

Pump casing

- Radially split volute casing
- Replaceable casing wear rings (optional for pump casing material C)

Depending on pump size and design:

- Volute casing with integrally cast pump feet (not for pump casing material G, motor size ≤ 180)
- Volute casing with integrally cast pump feet

Drive

- Efficiency class IE3 to IEC 60034-30

Standard design:

- KSB surface-cooled IEC three-phase current squirrel-cage motor
- Rated voltage (50 Hz) 220-240 V / 380-420 V ≤ 2.20 kW
- Rated voltage (50 Hz) 380-420 V / 660 - 725 V ≥ 3.00 kW
- Rated voltage (60 Hz) 440-480 V ≤ 2.60 kW
- Rated voltage (60 Hz) 440-480 V ≥ 3.60 kW
- Type of construction IM V1 ≤ 4.00 kW

- Type of construction IM V15 ≥ 5.50 kW
- Enclosure IP55
- Duty cycle: continuous duty S1
- Thermal class F with temperature sensor, 3 PTC thermistors

Explosion-proof design:

- KSB surface-cooled IEC three-phase current squirrel-cage motor
- Rated voltage (50 Hz) 220 - 240 V / 380 - 420 V ≤ 1.85 kW
- Rated voltage (50 Hz) 380 - 420 V / 660 - 725 V ≥ 2.50 kW
- Type of construction IM V1 ≤ 3.30 kW
- Type of construction IM V15 ≥ 4.60 kW
- Enclosure IP55 or IP54
- Duty cycle: continuous duty S1
- Type of protection EEx eb II
- Temperature class T3

Shaft seal

- Shaft equipped with replaceable shaft protecting sleeve in the shaft seal area
- Single mechanical seals and double mechanical seals to EN 12756

Impeller type

- Closed radial impeller with multiply curved vanes

Automation

Automation options:

- PumpDrive
- PumpMeter

4.6 Installation types

Horizontal installation, fastened below

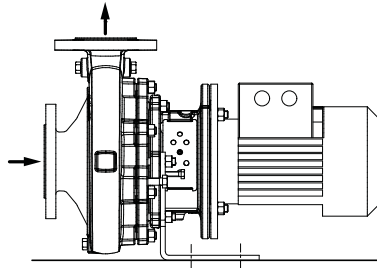

Pump sets with support foot up to motor size 112

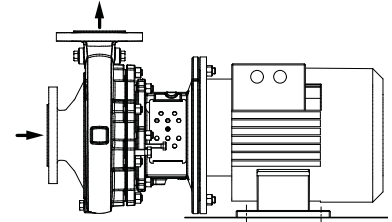

Pump sets, motor sizes 132 to 180

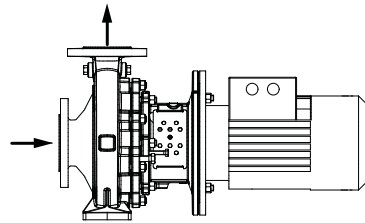

Pump sets with volute casing foot up to motor size 112

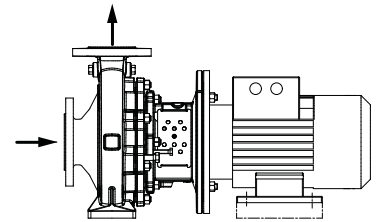

Pump sets with volute casing foot, motor sizes 132 to 180

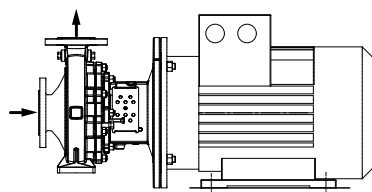

Pump sets, motor sizes 200 to 250, 2-pole

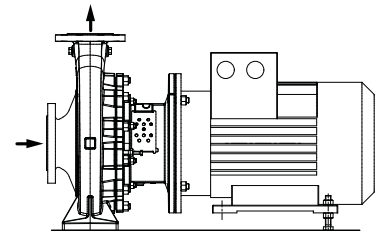

Pump sets, motor sizes 200 to 250, 4-pole

Horizontal installation, fastened above

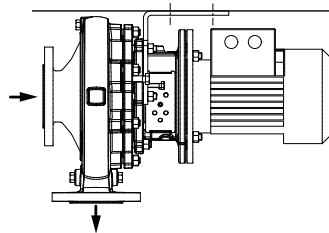

Pump sets up to motor size 112

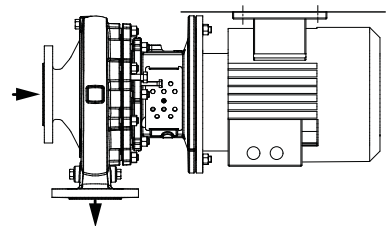

Pump sets, motor sizes 132 to 180

Vertical installation

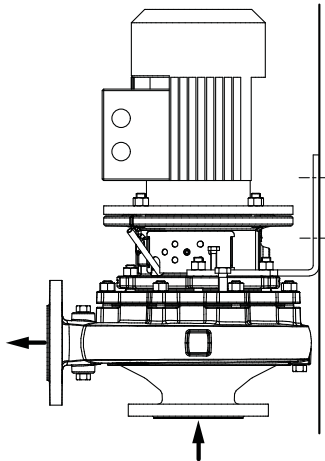

Pump sets up to motor size 112

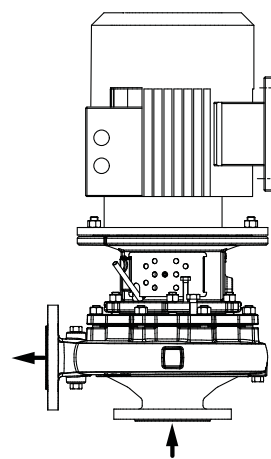

Pump sets, motor sizes 132 to 180

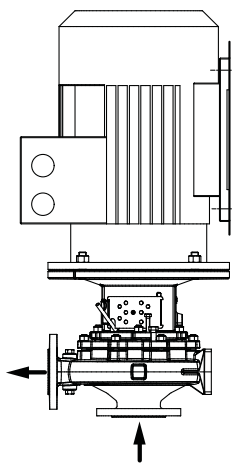

Pump sets, motor sizes 200 to 250, 2-pole

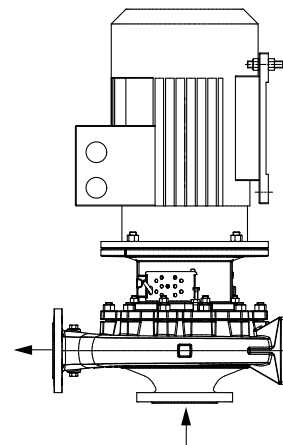

Pump sets, motor sizes 200 to 250, 4-pole

4.7 Configuration and function

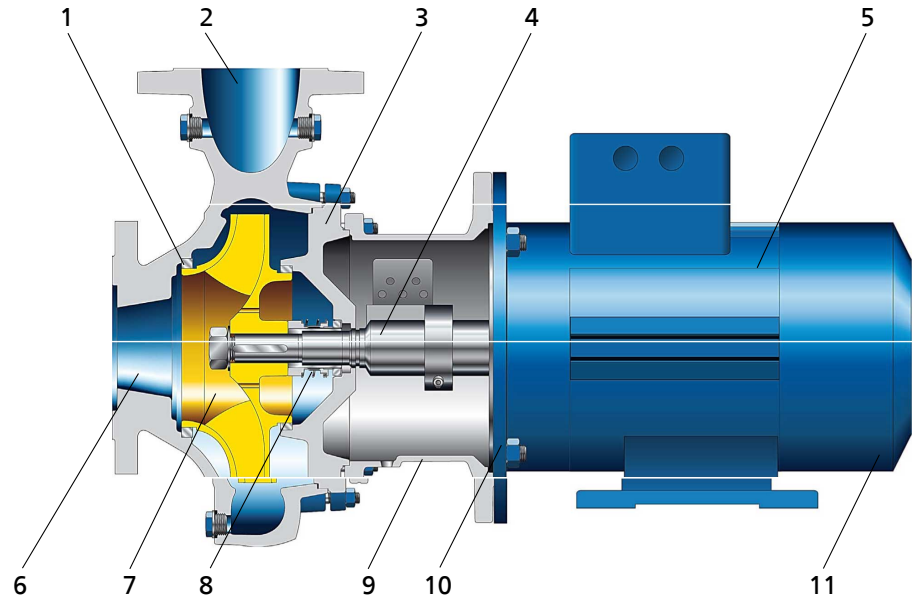

Fig. 5: Sectional drawing

1	Clearance gap	2	Discharge nozzle
3	Casing cover	4	Shaft
5	Motor housing	6	Suction nozzle
7	Impeller	8	Shaft seal
9	Drive lantern	10	Rolling element bearing
11	Rolling element bearing		

Design The pump is designed with an axial fluid inlet and a radial outlet. The hydraulic system is rigidly connected to the motor via a stub shaft.

Function The fluid enters the pump via the suction nozzle (6) and is accelerated outward by the rotating impeller (7). In the flow passage of the pump casing the kinetic energy of the fluid is converted into pressure energy. The fluid is pumped to the discharge nozzle (2), where it leaves the pump. The clearance gap (1) prevents any fluid from flowing back from the casing to the suction nozzle. At the rear side of the impeller, the shaft (4) enters the casing via the casing cover (3). The shaft passage through the cover is sealed to atmosphere with a dynamic shaft seal (8). The shaft runs in rolling element bearings (10 and 11), which are supported by a motor housing (5) linked with the pump casing and/or casing cover (3) via the drive lantern (9).

Sealing The pump is sealed by a standardised mechanical seal.

4.8 Noise characteristics

 Table 7: Surface sound pressure level L_{pA} ²⁾

Rated power input P_N [kW]	Pump set			
	1450 rpm [dB]	1750 rpm [dB]	2900 rpm [dB]	3500 rpm [dB]
0,25	53	54	-	-
0,37	54	55	-	-
0,55	55	56	-	-
0,75	56	57	66	-
1,1	57	58	66	69
1,5	58	59	67	70
2,2	59	60	67	70
3	60	61	68	71
4	61	62	68	71
5,5	62	63	70	73
7,5	64	65	71	74
11	65	66	73	76
15	67	68	74	77
18,5	68	69	75	78
22	69	70	76	79
30	70	71	77	80
37	71	72	78	81
45	73	74	78	81

4.9 Scope of supply

Depending on the model, the following items are included in the scope of supply:

- Pump

Drive

- Surface-cooled IEC frame three-phase squirrel-cage motor

Contact guard

- Cover plates on drive lantern to EN 294

4.10 Dimensions and weights

For dimensions and weights please refer to the general arrangement drawing/outline drawing of the pump/pump set.

2) Spatial average; as per ISO 3744 and EN 12639; valid for pump operation in the $Q/Q_{opt} = 0.80 - 1.1$ range and for non-cavitating operation. If noise levels are to be guaranteed: add +3 dB for measuring and constructional tolerance.

5 Installation at Site

5.1 Checking the site before installation

Place of installation

	<p>⚠ WARNING</p>
	<p>Installation on mounting surfaces which are unsecured and cannot support the load</p> <p>Personal injury and damage to property!</p> <ul style="list-style-type: none"> ▷ Use a concrete of compressive strength class C12/15 which meets the requirements of exposure class X0 to EN 206-1. ▷ The mounting surface must have set and must be completely horizontal and even. ▷ Observe the weights indicated.

1. Check the structural requirements.
All structural work required must have been prepared in accordance with the dimensions stated in the outline drawing/general arrangement drawing.

5.2 Installing the pump set

	<p>⚠ DANGER</p>
	<p>Static charging due to insufficient potential equalisation</p> <p>Explosion hazard!</p> <ul style="list-style-type: none"> ▷ Make sure that the connection between pump and baseplate is electrically conductive.

	<p>CAUTION</p>
	<p>Ingress of leakage into the motor</p> <p>Damage to the pump!</p> <ul style="list-style-type: none"> ▷ Never install the pump set with the "motor below".

Fastening

Examples of installation types (⇒ Section 4.6, Page 20)

Table 8: Fastening

Size	Type of fastening
Up to 112	Fix in place using the support foot or volute casing foot, or by fastening the pump to the piping (remove the support foot).
From 132-180	Fix in place using the motor foot or using the volute casing foot and motor foot.
From 200	Fix in place using the volute casing foot and motor support.

	NOTE
	<p>For motor sizes 132 or 160, the motor foot must be shimmed (20 mm shim height) for installation on a foundation.</p> <p>On some pump/motor combinations, the support foot/motor feet need to be shimmed for installation on a foundation.</p>

1. Position the pump set on the foundation and fasten it (see the "Fastening" table).
2. Place a spirit level on the discharge nozzle to align the pump set.
3. If the volute casing is turned, drill a drain hole in the volute casing (see the "Drain hole" table below).

Table 9: Drain hole

Sizes	Drain hole diameter
040-025-160 bis 100-080-315	G 3/8 ³⁾
125-100-160 bis 200-150-400	G 1/2 ³⁾

5.3 Piping

5.3.1 Connecting the piping

	⚠ DANGER
	<p>Impermissible loads acting on the pump nozzles</p> <p>Danger to life from leakage of hot, toxic, corrosive or flammable fluids!</p> <ul style="list-style-type: none"> ▷ Do not use the pump as an anchorage point for the piping. ▷ Anchor the pipes in close proximity to the pump and connect them properly without transmitting any stresses or strains. ▷ Take appropriate measures to compensate for thermal expansion of the piping.

	CAUTION
	<p>Incorrect earthing during welding work at the piping</p> <p>Destruction of rolling element bearings (pitting effect)!</p> <ul style="list-style-type: none"> ▷ Never earth the electric welding equipment on the pump or baseplate. ▷ Prevent current flowing through the rolling element bearings.

3) G = ISO 228/1

	NOTE
	<p>Installing check and shut-off elements in the system is recommended, depending on the type of plant and pump. However, such elements must not obstruct proper drainage or hinder disassembly of the pump.</p>

- ✓ Suction lift lines have been laid with a rising slope, suction head lines with a downward slope towards the pump.
- ✓ A flow stabilisation section having a length equivalent to at least twice the inside diameter of the suction flange has been provided upstream of the suction flange.
- ✓ The nominal diameters of the pipelines are equal to or greater than the nominal diameters of the pump nozzles.
- ✓ Adapters to larger nominal diameters are designed with a diffuser angle of approx. 8° to avoid excessive pressure losses.
- ✓ The pipelines have been anchored in close proximity to the pump and connected without transmitting any stresses or strains.
 1. Thoroughly clean, flush and blow through all vessels, pipelines and connections (especially of new installations).
 2. Before installing the pump in the piping, remove the flange covers on the suction and discharge nozzles of the pump.

	CAUTION
	<p>Welding beads, scale and other impurities in the piping Damage to the pump!</p> <ul style="list-style-type: none"> ▷ Remove any impurities from the piping. ▷ If necessary, install a filter. ▷ Observe the information in (⇒ Section 7.2.2.2, Page 44) .

3. Check that the inside of the pump is free from any foreign objects. Remove any foreign objects.
4. If required, install a filter in the piping (see drawing: Filter in the piping).

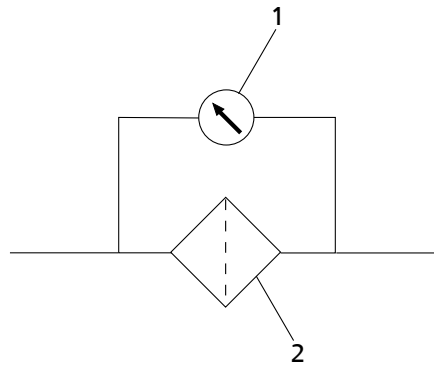



Fig. 6: Filter in the piping

1	Differential pressure gauge	2	Filter
---	-----------------------------	---	--------

	NOTE
	<p>Use a filter with laid-in wire mesh (mesh width 0.5 mm, wire diameter 0.25 mm) of corrosion-resistant material. Use a filter with a filter area three times the cross-section of the piping. Conical filters have proved suitable.</p>

5. Connect the pump nozzles to the piping.

	CAUTION
	<p>Aggressive flushing liquid and pickling agent Damage to the pump!</p> <p>▷ Match the cleaning operation mode and duration of flushing and pickling to the casing materials and seal materials used.</p>

5.3.2 Permissible forces and moments at the pump nozzles

The data on forces and moments apply to static piping loads only.

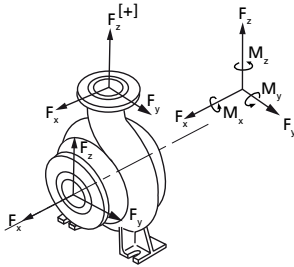

Fig. 7: Forces and moments at the pump nozzles

Table 10: Forces and moments at the pump nozzles for casing material G (JL1040/ A48 Cl. 35B)

Size	Suction nozzle								Discharge nozzle							
	DN	F _x	F _y	F _z	∑F	M _x	M _y	M _z	DN	F _x	F _y	F _z	∑F	M _x	M _y	M _z
		[N]	[N]	[N]	[N]	[Nm]	[Nm]	[Nm]		[N]	[N]	[N]	[N]	[Nm]	[Nm]	[Nm]
040-025-160	40	450	400	350	696	450	320	370	25	265	250	300	472	315	210	245
040-025-200	40	450	400	350	696	450	320	370	25	265	250	300	472	315	210	245
050-032-125.1	50	580	530	470	916	500	350	400	32	320	300	370	574	390	265	300
050-032-160.1	50	580	530	470	916	500	350	400	32	320	300	370	574	390	265	300
050-032-200.1	50	580	530	470	916	500	350	400	32	320	300	370	574	390	265	300
050-032-250.1	50	580	530	470	916	500	350	400	32	320	300	370	574	390	265	300
050-032-125	50	580	530	470	916	500	350	400	32	320	300	370	574	390	265	300
050-032-160	50	580	530	470	916	500	350	400	32	320	300	370	574	390	265	300
050-032-200	50	580	530	470	916	500	350	400	32	320	300	370	574	390	265	300
050-032-250	50	580	530	470	916	500	350	400	32	320	300	370	574	390	265	300
065-040-125	65	740	650	600	1153	530	390	420	40	400	350	450	696	450	320	370
065-040-160	65	740	650	600	1153	530	390	420	40	400	350	450	696	450	320	370
065-040-200	65	740	650	600	1153	530	390	420	40	400	350	450	696	450	320	370
065-040-250	65	740	650	600	1153	530	390	420	40	400	350	450	696	450	320	370
065-040-315	65	740	650	600	1153	530	390	420	40	400	350	450	696	450	320	370
065-050-125	65	740	650	600	1153	530	390	420	50	530	470	580	916	500	350	400
065-050-160	65	740	650	600	1153	530	390	420	50	530	470	580	916	500	350	400
065-050-200	65	740	650	600	1153	530	390	420	50	530	470	580	916	500	350	400
065-050-250	65	740	650	600	1153	530	390	420	50	530	470	580	916	500	350	400
065-050-315	65	740	650	600	1153	530	390	420	50	530	470	580	916	500	350	400
080-065-125	80	880	790	720	1385	560	400	460	65	650	600	740	1153	530	390	420
080-065-160	80	880	790	720	1385	560	400	460	65	650	600	740	1153	530	390	420
080-065-200	80	880	790	720	1385	560	400	460	65	650	600	740	1153	530	390	420
080-065-250	80	880	790	720	1385	560	400	460	65	650	600	740	1153	530	390	420
080-065-315	80	880	790	720	1385	560	400	460	65	650	600	740	1153	530	390	420
100-080-160	100	1180	1050	950	1843	620	440	510	80	790	720	880	1385	560	400	460
100-080-200	100	1180	1050	950	1843	620	440	510	80	790	720	880	1385	560	400	460
100-080-250	100	1180	1050	950	1843	620	440	510	80	790	720	880	1385	560	400	460

1173.8/06-EN

Size	Suction nozzle								Discharge nozzle							
	DN	Fx	Fy	Fz	ΣF	Mx	My	Mz	DN	Fx	Fy	Fz	ΣF	Mx	My	Mz
	[N]	[N]	[N]	[N]	[Nm]	[Nm]	[Nm]		[N]	[N]	[N]	[N]	[Nm]	[Nm]	[Nm]	
100-080-315	100	1180	1050	950	1843	620	440	510	80	790	720	880	1385	560	400	460
100-080-400	100	1180	1050	950	1843	620	440	510	80	790	720	880	1385	560	400	460
125-100-160	125	1400	1250	1120	2186	740	530	670	100	1050	950	1180	1843	620	440	510
125-100-200	125	1400	1250	1120	2186	740	530	670	100	1050	950	1180	1843	620	440	510
125-100-250	125	1400	1250	1120	2186	740	530	670	100	1050	950	1180	1843	620	440	510
125-100-315	125	1400	1250	1120	2186	740	530	670	100	1050	950	1180	1843	620	440	510
125-100-400	125	1400	1250	1120	2186	740	530	670	100	1050	950	1180	1843	620	440	510
150-125-200	150	1750	1600	1400	2754	880	610	720	125	1250	1120	1400	2186	740	530	670
150-125-250	150	1750	1600	1400	2754	880	610	720	125	1250	1120	1400	2186	740	530	670
150-125-315	150	1750	1600	1400	2754	880	610	720	125	1250	1120	1400	2186	740	530	670
150-125-400	150	1750	1600	1400	2754	880	610	720	125	1250	1120	1400	2186	740	530	670
200-150-200	200	2350	2100	1900	3680	1150	800	930	150	1600	1400	1750	2754	880	610	720
200-150-250	200	2350	2100	1900	3680	1150	800	930	150	1600	1400	1750	2754	880	610	720
200-150-315	200	2350	2100	1900	3680	1150	800	930	150	1600	1400	1750	2754	880	610	720
200-150-400	200	2350	2100	1900	3680	1150	800	930	150	1600	1400	1750	2754	880	610	720

Correction coefficients depending on material and temperature (see diagram below).

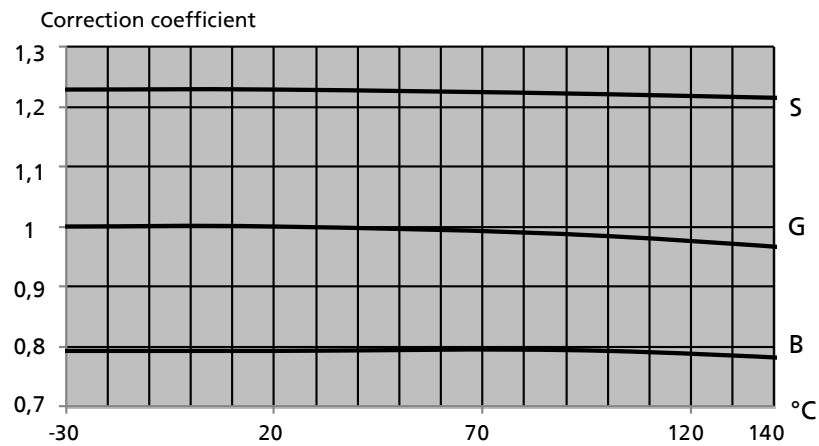

Fig. 8: Temperature/material correction diagram for casing materials G (EN-GJL-250/A48CL35B), S (EN-GJS-400-15/A536 GR 60-40-18) and B (CC480K-GS/B30 C90700)

Table 11: Forces and moments at the pump nozzles for casing material C (1.4408 / A743 Gr. CF8M)

Size	Suction nozzle								Discharge nozzle							
	DN	Fx	Fy	Fz	ΣF	Mx	My	Mz	DN	Fx	Fy	Fz	ΣF	Mx	My	Mz
	[N]	[N]	[N]	[N]	[Nm]	[Nm]	[Nm]		[N]	[N]	[N]	[N]	[Nm]	[Nm]	[Nm]	
040-25-160	40	970	780	650	1404	500	280	410	25	460	410	600	860	370	185	280
040-25-200	40	970	780	650	1404	500	280	410	25	460	410	600	860	370	185	280
050-32-125.1	50	1240	1010	830	1802	650	320	500	32	650	500	780	1132	415	230	320
050-32-160.1	50	1240	1010	830	1802	650	320	500	32	650	500	780	1132	415	230	320
050-32-200.1	50	1240	1010	830	1802	650	320	500	32	650	500	780	1132	415	230	320
050-32-250.1	50	1240	1010	830	1802	650	320	500	32	650	500	780	1132	415	230	320
050-32-125	50	1240	1010	830	1802	650	320	500	32	650	500	780	1132	415	230	320
050-32-160	50	1240	1010	830	1802	650	320	500	32	650	500	780	1132	415	230	320
050-32-200	50	1240	1010	830	1802	650	320	500	32	650	500	780	1132	415	230	320
050-32-250	50	1240	1010	830	1802	650	320	500	32	650	500	780	1132	415	230	320
065-40-125	65	1600	1300	1050	2314	1050	550	780	40	780	640	1000	1421	500	280	415
065-40-160	65	1600	1300	1050	2314	1050	550	780	40	780	640	1000	1421	500	280	415

1173:8/06-EN

Size	Suction nozzle								Discharge nozzle							
	DN	Fx	Fy	Fz	∑F	Mx	My	Mz	DN	Fx	Fy	Fz	∑F	Mx	My	Mz
		[N]	[N]	[N]	[N]	[Nm]	[Nm]	[Nm]		[N]	[N]	[N]	[N]	[Nm]	[Nm]	[Nm]
065-40-200	65	1600	1300	1050	2314	1050	550	780	40	780	640	1000	1421	500	280	415
065-40-250	65	1600	1300	1050	2314	1050	550	780	40	780	640	1000	1421	500	280	415
065-40-315	65	1600	1300	1050	2314	1050	550	780	40	780	640	1000	1421	500	280	415
065-50-125	65	1600	1300	1050	2314	1050	550	780	50	1000	830	1250	1803	650	320	500
065-50-160	65	1600	1300	1050	2314	1050	550	780	50	1000	830	1250	1803	650	320	500
065-50-200	65	1600	1300	1050	2314	1050	550	780	50	1000	830	1250	1803	650	320	500
065-50-250	65	1600	1300	1050	2314	1050	550	780	50	1000	830	1250	1803	650	320	500
065-50-315	65	1600	1300	1050	2314	1050	550	780	50	1000	830	1250	1803	650	320	500
080-65-125	80	2000	1550	1300	2845	1330	690	1010	65	1300	1050	1600	2314	1050	550	790
080-65-160	80	2000	1550	1300	2845	1330	690	1010	65	1300	1050	1600	2314	1050	550	790
080-65-200	80	2000	1550	1300	2845	1330	690	1010	65	1300	1050	1600	2314	1050	550	790
080-65-250	80	2000	1550	1300	2845	1330	690	1010	65	1300	1050	1600	2314	1050	550	790
080-65-315	80	2000	1550	1300	2845	1330	690	1010	65	1300	1050	1600	2314	1050	550	790
100-80-160	100	2500	1950	1600	3551	1850	900	1400	80	1550	1300	1950	2810	1350	690	1000
100-80-200	100	2500	1950	1600	3551	1850	900	1400	80	1550	1300	1950	2810	1350	690	1000
100-80-250	100	2500	1950	1600	3551	1850	900	1400	80	1550	1300	1950	2810	1350	690	1000
100-80-315	100	2500	1950	1600	3551	1850	900	1400	80	1550	1300	1950	2810	1350	690	1000
100-80-400	100	2500	1950	1600	3551	1850	900	1400	80	1550	1300	1950	2810	1350	690	1000
125-100-160	125	3400	2700	2200	4867	2500	1300	1950	100	2000	1600	2500	3579	1850	900	1400
125-100-200	125	3400	2700	2200	4867	2500	1300	1950	100	2000	1600	2500	3579	1850	900	1400
125-100-250	125	3400	2700	2200	4867	2500	1300	1950	100	2000	1600	2500	3579	1850	900	1400
125-100-315	125	3400	2700	2200	4867	2500	1300	1950	100	2000	1600	2500	3579	1850	900	1400
125-100-400	125	3400	2700	2200	4867	2500	1300	1950	100	2000	1600	2500	3579	1850	900	1400
150-125-200	150	4300	3450	2850	6206	3200	1600	2450	125	2700	2200	3400	4867	2550	1300	1900
150-125-250	150	4300	3450	2850	6206	3200	1600	2450	125	2700	2200	3400	4867	2550	1300	1900
150-125-315	150	4300	3450	2850	6206	3200	1600	2450	125	2700	2200	3400	4867	2550	1300	1900
150-125-400	150	4300	3450	2850	6206	3200	1600	2450	125	2700	2200	3400	4867	2550	1300	1900
200-150-200	200	6750	5250	4300	9572	4850	2450	3550	150	3450	2850	4300	6206	3150	1600	2450
200-150-250	200	6750	5250	4300	9572	4850	2450	3550	150	3450	2850	4300	6206	3150	1600	2450
200-150-315	200	6750	5250	4300	9572	4850	2450	3550	150	3450	2850	4300	6206	3150	1600	2450
200-150-400	200	6750	5250	4300	9572	4850	2450	3550	150	3450	2850	4300	6206	3150	1600	2450

5.3.3 Vacuum balance line

	NOTE
	Where fluid has to be pumped out of a vessel under vacuum, installing a vacuum balance line is recommended.

The following rules apply to vacuum balance lines:

- Minimum nominal line diameter 25 mm.
- The line extends above the highest permissible fluid level in the vessel.

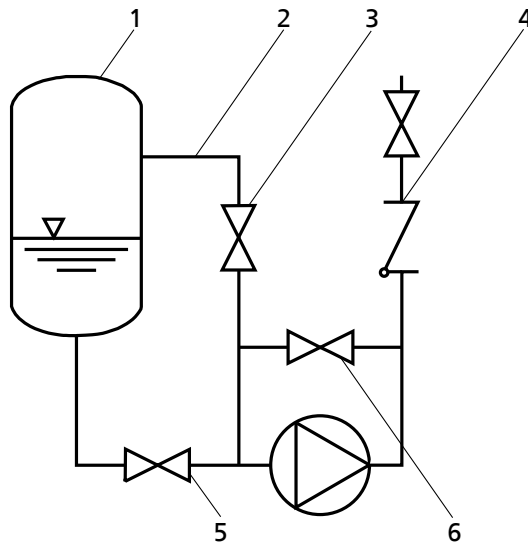

Fig. 9: Vacuum balance system

1	Vessel under vacuum	2	Vacuum balance line
3	Shut-off element	4	Swing check valve
5	Main shut-off element	6	Vacuum-tight shut-off element



	NOTE
	<p>An additional line fitted with a shut-off valve (from the pump discharge nozzle to the balance line) facilitates venting of the pump before start-up.</p>

5.3.4 Auxiliary connections



 	⚠ DANGER
	<p>Risk of potentially explosive atmosphere by incompatible fluids mixing in the auxiliary piping</p> <p>Risk of burns!</p> <p>Explosion hazard!</p> <ul style="list-style-type: none"> ▸ Make sure that the barrier fluid or quench liquid are compatible with the fluid handled.

	⚠ WARNING
	<p>Failure to use or incorrect use of auxiliary connections (e.g. barrier fluid, flushing liquid, etc.)</p> <p>Risk of injury from escaping fluid!</p> <p>Risk of burns!</p> <p>Malfunction of the pump!</p> <ul style="list-style-type: none"> ▸ Refer to the general arrangement drawing, the piping layout and pump markings (if any) for the quantity, dimensions and locations of auxiliary connections. ▸ Use the auxiliary connections provided.

5.4 Enclosure/insulation

	<p>⚠ DANGER</p> <p>Explosive atmosphere forming due to insufficient venting Explosion hazard!</p> <ul style="list-style-type: none"> ▷ Make sure the space between the casing cover/discharge cover and the motor flange is sufficiently vented. ▷ Do not cover the perforations of the contact guards at the drive lantern (e.g. by insulation).
	<p>⚠ WARNING</p> <p>The volute casing and casing/discharge cover take on the same temperature as the fluid handled Risk of burns!</p> <ul style="list-style-type: none"> ▷ Insulate the volute casing. ▷ Fit protective equipment.
	<p>CAUTION</p> <p>Heat build-up inside the drive lantern Damage to the bearing!</p> <ul style="list-style-type: none"> ▷ Never insulate the casing cover and the drive lantern.

5.5 Electrical connection

	<p>⚠ DANGER</p> <p>Electrical connection work by unqualified personnel Risk of fatal injury due to electric shock!</p> <ul style="list-style-type: none"> ▷ Always have the electrical connections installed by a trained and qualified electrician. ▷ Observe regulations IEC 60364 and, for explosion-proof models, EN 60079.
	<p>⚠ WARNING</p> <p>Incorrect connection to the mains Damage to the mains network, short circuit!</p> <ul style="list-style-type: none"> ▷ Observe the technical specifications of the local energy supply companies.
<ol style="list-style-type: none"> 1. Check the available mains voltage against the data on the motor name plate. 2. Select an appropriate starting method. 	
	<p>NOTE</p> <p>Installing a motor protection device is recommended.</p>

5.5.1 Setting the time relay

	CAUTION
	<p>Switchover between star and delta on three-phase motors with star-delta starting takes too long.</p> <p>Damage to the pump (set)!</p> <ul style="list-style-type: none"> ▷ Keep switch-over intervals between star and delta as short as possible.

Table 12: Time relay settings for star-delta starting:

Motor rating [kW]	Y time to be set [s]
≤ 30	< 3
> 30	< 5

5.5.2 Earthing

	⚠ DANGER
	<p>Electrostatic charging</p> <p>Explosion hazard!</p> <p>Fire hazard!</p> <p>Damage to the pump set!</p> <ul style="list-style-type: none"> ▷ Connect the PE conductor to the earthing terminal provided.

5.5.3 Connecting the motor

	NOTE
	<p>In compliance with IEC 60034-8, three-phase motors are always wired for clockwise rotation (looking at the motor shaft stub).</p> <p>The pump's direction of rotation is indicated by an arrow on the pump.</p>

1. Match the motor's direction of rotation to that of the pump.
2. Observe the manufacturer's product literature supplied with the motor.

5.6 Checking the direction of rotation

	⚠ DANGER
	<p>Temperature increases resulting from contact between rotating and stationary components</p> <p>Explosion hazard!</p> <p>Damage to the pump set!</p> <ul style="list-style-type: none"> ▷ Never check the direction of rotation by starting up the unfilled pump.

	⚠ WARNING
	<p>Hands inside the pump casing</p> <p>Risk of injuries, damage to the pump!</p> <ul style="list-style-type: none"> ▷ Always disconnect the pump set from the power supply and secure it against unintentional start-up before inserting your hands or other objects into the pump.

1173.8/06-EN

	CAUTION
	<p>Drive and pump running in the wrong direction of rotation</p> <p>Damage to the pump!</p> <ul style="list-style-type: none">▷ Refer to the arrow indicating the direction of rotation on the pump.▷ Check the direction of rotation. If required, check the electrical connection and correct the direction of rotation.

The correct direction of rotation of the motor and pump is clockwise (seen from the drive end).

1. Start the motor and stop it again immediately to determine the motor's direction of rotation.
2. Check the direction of rotation.
The motor's direction of rotation must match the arrow indicating the direction of rotation on the pump.
3. If the motor runs in the wrong direction of rotation, check the electrical connection of the motor and the control system, if applicable.

6 Commissioning/Start-up/Shutdown





6.1 Commissioning/Start-up

6.1.1 Prerequisites for commissioning/start-up

Before commissioning/starting up the pump set, make sure that the following conditions are met:

- The pump set has been properly connected to the power supply and is equipped with all protection devices. (⇒ Section 5.5, Page 31)
- The pump has been primed with the fluid to be handled. The pump has been vented.
- The direction of rotation has been checked. (⇒ Section 5.6, Page 32)
- All auxiliary connections required are connected and operational.
- The lubricants have been checked.
- After prolonged shutdown of the pump (set), the activities required for returning the equipment to service have been carried out. (⇒ Section 6.4, Page 39)
- The lock washers, if any, have been removed from the shaft groove.

6.1.2 Priming and venting the pump

	<p>⚠ DANGER</p>
	<p>Risk of potentially explosive atmosphere inside the pump Explosion hazard!</p> <ul style="list-style-type: none"> ▷ The pump internals in contact with the fluid to be handled, including the seal chamber and auxiliary systems, must be filled with the fluid to be handled at all times. ▷ Provide sufficient inlet pressure. ▷ Provide an appropriate monitoring system.
 	<p>⚠ DANGER</p>
	<p>Risk of potentially explosive atmosphere by incompatible fluids mixing in the auxiliary piping Risk of burns! Explosion hazard!</p> <ul style="list-style-type: none"> ▷ Make sure that the barrier fluid or quench liquid are compatible with the fluid handled.
	<p>CAUTION</p>
	<p>Increased wear due to dry running Damage to the pump set!</p> <ul style="list-style-type: none"> ▷ Never operate the pump set without liquid fill. ▷ Never close the shut-off element in the suction line and/or supply line during pump operation.

1. Vent the pump and suction line and prime both with the fluid to be handled. Connection 6D can be used for venting.
For vertical installation with the motor on top use connection 5B (if any) for venting. (see general assembly drawing (⇒ Section 9.1.1, Page 57) and (⇒ Section 9.1.2, Page 59))
2. Fully open the shut-off element in the suction line.

3. Fully open all auxiliary feed lines (barrier fluid, flushing liquid, etc.), if any.
4. Open the shut-off valve (3), if any, in the vacuum balance line (2) and close the vacuum-tight shut-off valve (6), if any. (⇒ Section 5.3.3, Page 29)

	NOTE
<p>For design-inherent reasons some unfilled volume in the hydraulic system cannot be excluded after the pump has been primed for commissioning/start-up. However, once the motor is started up the pumping effect will immediately fill this volume with the fluid handled.</p>	

6.1.3 Start-up

	⚠ DANGER
<p>Non-compliance with the permissible pressure and temperature limits if the pump is operated with the suction and/or discharge line closed. Explosion hazard! Hot or toxic fluids escaping!</p> <ul style="list-style-type: none"> ▷ Never operate the pump with the shut-off elements in the suction line and/or discharge line closed. ▷ Only start up the pump set with the discharge-side shut-off element slightly or fully open. 	

	⚠ DANGER
<p>Excessive temperatures due to dry running or excessive gas content in the fluid handled Explosion hazard! Damage to the pump set!</p> <ul style="list-style-type: none"> ▷ Never operate the pump set without liquid fill. ▷ Prime the pump as per operating instructions. ▷ Always operate the pump within the permissible operating range. 	

	CAUTION
<p>Abnormal noises, vibrations, temperatures or leakage Damage to the pump!</p> <ul style="list-style-type: none"> ▷ Switch off the pump (set) immediately. ▷ Eliminate the causes before returning the pump set to service. 	

- ✓ The system piping has been cleaned.
- ✓ The pump, suction line and inlet tank, if any, have been vented and primed with the fluid to be pumped.
- ✓ The lines for priming and venting have been closed.

	CAUTION
	<p>Start-up against open discharge line Motor overload!</p> <ul style="list-style-type: none"> ▷ Make sure the motor has sufficient power reserves. ▷ Use a soft starter. ▷ Use speed control.

1. Fully open the shut-off element in the suction head/suction lift line.
2. Close or slightly open the shut-off element in the discharge line.
3. Start up the motor.
4. Immediately after the pump has reached full rotational speed, slowly open the shut-off element in the discharge line and adjust it to comply with the duty point.

6.1.4 Checking the shaft seal

Mechanical seal The mechanical seal only leaks slightly or invisibly (as vapour) during operation. Mechanical seals are maintenance-free.

6.1.5 Shutdown

	CAUTION
	<p>Heat build-up inside the pump Damage to the shaft seal!</p> <ul style="list-style-type: none"> ▷ Depending on the type of installation, the pump set requires sufficient after-run time – with the heat source switched off – until the fluid handled has cooled down.

	CAUTION
	<p>Backflow of fluid handled is not permitted Motor or winding damage! Mechanical seal damage!</p> <ul style="list-style-type: none"> ▷ Close the shut-off elements.

- ✓ The shut-off element in the suction line is and remains open.
1. Close the shut-off element in the discharge line.
 2. Switch off the motor and make sure the pump set runs down smoothly to a standstill.

	NOTE
	<p>If the discharge line is equipped with a non-return or check valve, the shut-off element may remain open provided that the system conditions and system regulations are considered and observed.</p>

For prolonged shutdown periods:

1. Close the shut-off element in the suction line.
2. Close any auxiliary lines.
 If the fluid to be handled is fed in under vacuum, also supply the shaft seal with barrier fluid during standstill.

	CAUTION
	<p>Risk of freezing during prolonged pump shutdown periods Damage to the pump!</p> <ul style="list-style-type: none"> ▷ Drain the pump and the cooling/heating chambers (if any) or otherwise protect them against freezing.

6.2 Operating limits

	! DANGER
	<p>Non-compliance with operating limits for pressure, temperature, fluid handled and speed Explosion hazard! Hot or toxic fluid could escape!</p> <ul style="list-style-type: none"> ▷ Comply with the operating data specified in the data sheet. ▷ Never use the pump for handling fluids it is not designed for. ▷ Avoid prolonged operation against a closed shut-off element. ▷ Never operate the pump at temperatures, pressures or speeds exceeding those indicated in the data sheet, on the name plate or in unless the written consent of the manufacturer has been obtained.

	! DANGER
	<p>Formation of a potentially explosive atmosphere inside the pump Explosion hazard!</p> <ul style="list-style-type: none"> ▷ When draining tanks take suitable measures to prevent dry running of the pump (e.g. fill level monitoring).

6.2.1 Ambient temperature

	CAUTION
	<p>Operation outside the permissible ambient temperature Damage to the pump (set)!</p> <ul style="list-style-type: none"> ▷ Observe the specified limits for permissible ambient temperatures.

Observe the following parameters and values during operation:

Table 13: Permissible ambient temperatures

Permissible ambient temperature	Value
Maximum	40 °C
Minimum	See data sheet.

6.2.2 Frequency of starts

	! DANGER
	<p>Excessive surface temperature of the motor Explosion hazard! Damage to the motor!</p> <ul style="list-style-type: none"> ▷ In case of explosion-proof motors, observe the frequency of starts specified in the manufacturer's product literature.

The frequency of starts is determined by the maximum temperature increase of the motor. The frequency of starts depends on the power reserves of the motor in steady-state operation and on the starting conditions (DOL starting, star-delta starting, moments of inertia, etc). If the start-ups are evenly spaced over the period indicated, the following limits serve as orientation for start-up with the discharge-side shut-off valve slightly open:

Table 14: Frequency of starts

Impeller material	Maximum frequency of starts
	[Start-ups/hour]
G (JL1040/ A48CL35B)	15
B (CC480K-GS/B30 C90700)	6
C (1.4408/ A743 GR CF8M)	

	CAUTION
	<p>Re-starting while motor is still running down Damage to the pump (set)!</p> <p>▷ Do not re-start the pump set before the pump rotor has come to a standstill.</p>

6.2.3 Fluid handled

6.2.3.1 Flow rate

Table 15: Flow rate

Temperature range (t)	Minimum flow rate	Maximum flow rate
-30 to +70 °C	≈ 15 % of $Q_{opt}^{4)}$	See hydraulic characteristic curves
> 70 to +140 °C	≈ 25 % of $Q_{opt}^{4)}$	

The calculation formula below can be used to check if an additional heat build-up could lead to a dangerous temperature increase at the pump surface.

$$T_o = T_f + \Delta \vartheta$$

$$\Delta \vartheta = \frac{g \times H}{c \times \eta} \times (1 - \eta)$$

Table 16: Key

Symbol	Description	Unit
c	Specific heat capacity	J/kg K
g	Acceleration due to gravity	m/s ²
H	Pump discharge head	m
T _f	Fluid temperature	°C
T _o	Temperature at the casing surface	°C
η	Pump efficiency at duty point	-
Δt ^ϑ	Temperature difference	K

6.2.3.2 Density of the fluid handled

The power input of the pump set will change in proportion to the density of the fluid handled.

4) Best efficiency point

	CAUTION
	<p>Impermissibly high density of the fluid handled Motor overload!</p> <ul style="list-style-type: none"> ▷ Observe the information about fluid density in the data sheet. ▷ Make sure the motor has sufficient power reserves.

6.2.3.3 Abrasive fluids

When the pump handles fluids containing abrasive substances, increased wear of the hydraulic system and the shaft seal are to be expected. In this case, reduce the commonly recommended inspection intervals.

The fluid handled may contain abrasive particles up to a maximum content of 5 g/m³ and a maximum particle size of 0.5 mm.

6.3 Shutdown/storage/preservation

6.3.1 Measures to be taken for shutdown

The pump (set) remains installed

- ✓ Sufficient fluid is supplied for the functional check run of the pump.
 1. For prolonged shutdown periods, start up the pump (set) regularly between once a month and once every three months for approximately five minutes.
 - ⇒ This will prevent the formation of deposits within the pump and the pump intake area.

The pump (set) is removed from the piping and stored

- ✓ The pump has been properly drained.
- ✓ The safety instructions for dismantling the pump have been observed. (⇒ Section 7.4.1, Page 45)
 1. Spray-coat the inside wall of the pump casing and, in particular, the impeller clearance areas with a preservative.
 2. Spray the preservative through the suction nozzle and discharge nozzle. It is advisable to then close the pump nozzles (e.g. with plastic caps).
 3. Oil or grease all exposed machined parts and surfaces of the pump (with silicone-free oil or grease, food-approved if required) to protect them against corrosion.

Observe the additional instructions on preservation. (⇒ Section 3.3, Page 13)

If the pump set is to be stored temporarily, only preserve the wetted components made of low-alloy materials. Commercially available preservatives can be used for this purpose. Observe the manufacturer's instructions for application/removal.

6.4 Returning to service

For returning the equipment to service observe the sections on commissioning/start-up and the operating limits. (⇒ Section 6.1, Page 34) (⇒ Section 6.2, Page 37)

In addition, carry out all servicing/maintenance operations before returning the pump (set) to service. (⇒ Section 7, Page 41)

	! WARNING
	<p>Failure to re-install or re-activate protective devices Risk of injury from moving parts or escaping fluid!</p> <ul style="list-style-type: none"> ▷ As soon as the work is completed, properly re-install and re-activate any safety-relevant devices and protective devices.

1173.8/06-EN







NOTE

If the equipment has been out of service for more than one year, replace all elastomer seals.

7 Servicing/Maintenance

7.1 Safety regulations

	<p>⚠ DANGER</p> <p>Sparks produced during servicing work Explosion hazard!</p> <ul style="list-style-type: none"> ▷ Observe the safety regulations in force at the place of installation! ▷ Always perform maintenance work on explosion-proof pump sets outside potentially explosive atmospheres.
	<p>⚠ DANGER</p> <p>Improperly serviced pump set Explosion hazard! Damage to the pump set!</p> <ul style="list-style-type: none"> ▷ Service the pump set regularly. ▷ Prepare a maintenance schedule with special emphasis on lubricants and shaft seal.
<p>The operator ensures that maintenance, inspection and installation are performed by authorised, qualified specialist personnel who are thoroughly familiar with the manual.</p>	
	<p>⚠ WARNING</p> <p>Unintentional starting of the pump set Risk of injury by moving components and shock currents!</p> <ul style="list-style-type: none"> ▷ Ensure that the pump set cannot be started unintentionally. ▷ Always make sure the electrical connections are disconnected before carrying out work on the pump set.
	<p>⚠ DANGER</p> <p>Improper cleaning of coated pump surfaces Explosion hazard by electrostatic discharge!</p> <ul style="list-style-type: none"> ▷ When cleaning coated pump surfaces in atmospheres of Explosion group IIC, use suitable anti-static equipment.
	<p>⚠ WARNING</p> <p>Fluids handled, consumables and supplies which are hot and/or pose a health hazard Risk of injury!</p> <ul style="list-style-type: none"> ▷ Observe all relevant laws. ▷ When draining the fluid take appropriate measures to protect persons and the environment. ▷ Decontaminate pumps which handle fluids posing a health hazard.

	WARNING
	<p>Insufficient stability Risk of crushing hands and feet!</p> <ul style="list-style-type: none"> ▷ During assembly/dismantling, secure the pump (set)/pump parts to prevent tilting or tipping over.

A regular maintenance schedule will help avoid expensive repairs and contribute to trouble-free, reliable operation of the pump, pump set and pump parts with a minimum of servicing/maintenance expenditure and work.

	NOTE
	<p>All maintenance work, service work and installation work can be carried out by KSB Service or authorised workshops. For contact details please refer to the enclosed "Addresses" booklet or visit "www.ksb.com/contact" on the Internet.</p>

Never use force when dismantling and reassembling the pump set.

7.2 Servicing/Inspection

7.2.1 Supervision of operation

	DANGER
	<p>Risk of potentially explosive atmosphere inside the pump Explosion hazard!</p> <ul style="list-style-type: none"> ▷ The pump internals in contact with the fluid to be handled, including the seal chamber and auxiliary systems, must be filled with the fluid to be handled at all times. ▷ Provide sufficient inlet pressure. ▷ Provide an appropriate monitoring system.

 	DANGER
	<p>Incorrectly serviced shaft seal Explosion hazard! Hot, toxic fluid escaping! Damage to the pump set! Risk of burns! Fire hazard!</p> <ul style="list-style-type: none"> ▷ Regularly service the shaft seal.

 	DANGER
	<p>Excessive temperatures as a result of bearings running hot or defective bearing seals Explosion hazard! Fire hazard! Damage to the pump set!</p> <ul style="list-style-type: none"> ▷ Regularly check the rolling element bearings for running noises.

	CAUTION
	<p>Increased wear due to dry running Damage to the pump set!</p> <ul style="list-style-type: none"> ▷ Never operate the pump set without liquid fill. ▷ Never close the shut-off element in the suction line and/or supply line during pump operation.
	CAUTION
	<p>Impermissibly high temperature of fluid handled Damage to the pump!</p> <ul style="list-style-type: none"> ▷ Prolonged operation against a closed shut-off element is not permitted (heating up of the fluid). ▷ Observe the temperature limits in the data sheet and in the section on operating limits. (⇒ Section 6.2, Page 37)



While the pump is in operation, observe and check the following:

- The pump must run quietly and free from vibrations at all times.
- Check the shaft seal. (⇒ Section 6.1.4, Page 36)
- Check the static sealing elements for leakage.
- Check the rolling element bearings for running noises.
Vibrations, noise and an increase in current input occurring during unchanged operating conditions indicate wear.
- Monitor the correct functioning of any auxiliary connections.
- Monitor the stand-by pump.
To make sure that stand-by pumps are ready for operation, start them up once a week.
- Monitor the bearing temperature.
The bearing temperature must not exceed 90 °C (measured on the motor housing).

	CAUTION
	<p>Operation outside the permissible bearing temperature Damage to the pump!</p> <ul style="list-style-type: none"> ▷ The bearing temperature of the pump (set) must never exceed 90 °C (measured on the outside of the motor housing).

	NOTE
	<p>After commissioning, increased temperatures may occur at grease-lubricated rolling element bearings due to the running-in process. The final bearing temperature is only reached after a certain period of operation (up to 48 hours depending on the conditions).</p>

7.2.2 Inspection work

	<p>⚠ DANGER</p>
	<p>Excessive temperatures caused by friction, impact or frictional sparks Explosion hazard! Fire hazard! Damage to the pump set!</p> <ul style="list-style-type: none"> ▷ Regularly check the coupling guard, plastic components and other guards of rotating parts for deformation and sufficient distance from rotating parts.
	<p>⚠ DANGER</p>
	<p>Static charging due to insufficient potential equalisation Explosion hazard!</p> <ul style="list-style-type: none"> ▷ Make sure that the connection between pump and baseplate is electrically conductive.

7.2.2.1 Checking the clearances

To check the clearances, remove the back pull-out unit.
If the clearance is larger than permitted (see the following table), fit a new casing wear ring 502.1 and/or 502.2.
The clearances specified refer to the impeller diameter.

Table 17: Clearances between impeller and casing and/or between impeller and casing cover

Impeller material	Permissible clearance	
	New	Maximum
G (JL1040/ A48CL35B) B (CC480K-GS/B30 C90700)	0,3 mm	0,9 mm
C (1.4408/ A743 GR CF8M)	0,5 mm	1,5 mm

7.2.2.2 Cleaning filters

	<p>CAUTION</p>
	<p>Insufficient inlet pressure due to clogged filter in the suction line Damage to the pump!</p> <ul style="list-style-type: none"> ▷ Monitor contamination of filter with suitable means (e.g. differential pressure gauge). ▷ Clean filter at appropriate intervals.

7.3 Drainage/cleaning

	WARNING
	<p>Fluids handled, consumables and supplies which are hot and/or pose a health hazard</p> <p>Hazard to persons and the environment!</p> <ul style="list-style-type: none"> ▸ Collect and properly dispose of flushing fluid and any fluid residues. ▸ Wear safety clothing and a protective mask if required. ▸ Observe all legal regulations on the disposal of fluids posing a health hazard.

1. Use connection 6B to drain the fluid handled. (⇒ Section 9.1.1, Page 57)
(⇒ Section 9.1.2, Page 59)
2. Always flush the pump if it has been used for handling noxious, explosive, hot or other hazardous fluids.
Always flush and clean the pump before transporting it to the workshop.
Provide a certificate of decontamination for the pump. (⇒ Section 11, Page 64)

7.4 Dismantling the pump set

7.4.1 General information/Safety regulations

	DANGER
	<p>Insufficient preparation of work on the pump (set)</p> <p>Risk of injury!</p> <ul style="list-style-type: none"> ▸ Properly shut down the pump set. (⇒ Section 6.1.5, Page 36) ▸ Close the shut-off elements in the suction line and discharge line. ▸ Drain the pump and release the pump pressure. ▸ Shut off any auxiliary feed lines. ▸ Allow the pump set to cool down to ambient temperature.
	WARNING
	<p>Unqualified personnel performing work on the pump (set)</p> <p>Risk of injury!</p> <ul style="list-style-type: none"> ▸ Always have repair work and maintenance work performed by specially trained, qualified personnel.
	WARNING
	<p>Hot surface</p> <p>Risk of injury!</p> <ul style="list-style-type: none"> ▸ Allow the pump set to cool down to ambient temperature.
	WARNING
	<p>Improper lifting/moving of heavy assemblies or components</p> <p>Personal injury and damage to property!</p> <ul style="list-style-type: none"> ▸ Use suitable transport devices, lifting equipment and lifting tackle to move heavy assemblies or components.

Always observe the safety instructions and information. (⇒ Section 7.1, Page 41)

For any work on the motor, observe the instructions of the relevant motor manufacturer.

For dismantling and reassembly observe the exploded views and the general assembly drawing. (⇒ Section 9.1, Page 57)

In the event of damage you can always contact our service departments.

	NOTE
	<p>All maintenance work, service work and installation work can be carried out by KSB Service or authorised workshops. For contact details please refer to the enclosed "Addresses" booklet or visit "www.ksb.com/contact" on the Internet.</p>

	NOTE
	<p>After a prolonged period of operation the individual components may be hard to pull off the shaft. If this is the case, use a brand name penetrating agent and/or - if possible - an appropriate puller.</p>

7.4.2 Preparing the pump set

1. De-energise the pump set and secure it against unintentional start-up.
2. Reduce pressure in the piping by opening a consumer installation.
3. Disconnect and remove all auxiliary pipework.

7.4.3 Dismantling the complete pump set

	NOTE
	<p>The pump casing can remain installed in the piping for further dismantling.</p>

✓ The notes and steps stated in (⇒ Section 7.4.1, Page 45) to (⇒ Section 7.4.2, Page 46) have been observed/carried out.

1. Disconnect the discharge and suction nozzle from the piping.
2. Depending on the pump/motor size, unscrew the bolts that fix the support foot and/or motor foot to the foundation.
3. Remove the complete pump set from the piping.

7.4.4 Removing the motor

	⚠ WARNING
	<p>Motor tipping over Risk of crushing hands and feet!</p> <p>▷ Suspend or support the motor to prevent it from tipping over.</p>

✓ The notes and steps stated in (⇒ Section 7.4.1, Page 45) to (⇒ Section 7.4.3, Page 46) have been observed/carried out.

1. Depending on the pump/motor size, unscrew the bolts that fix the motor foot to the foundation.
2. Undo bolts of cover plates 68-3.01/02.
3. Remove cover plates 68-3.01/02 from drive lantern 341.
4. Undo hexagon head bolts 901.5.
5. Insert both lock washers 931.95 into the groove in shaft 210.
6. Tighten hexagon head bolts 901.5.
7. Undo hexagon nuts 920.11.
8. Remove the motor.

7.4.5 Removing the back pull-out unit

	⚠ WARNING
	Back pull-out unit tilting Risk of squashing hands and feet! ▷ Suspend or support the back pull-out unit at the pump end.

✓ The notes and steps stated in (⇒ Section 7.4.1, Page 45) to (⇒ Section 7.4.4, Page 46) have been observed/carried out.

1. If required, suspend or support the back pull-out unit to prevent it from tipping over.
2. Undo hexagon nut 920.1 at the volute casing.
3. Use forcing screws 901.30 to remove the back pull-out unit from its seat in the volute casing. Pull the back pull-out unit completely out of volute casing 102.
4. Remove and dispose of gasket 400.10.
5. Place the back pull-out unit on a clean and level surface.

7.4.6 Removing the impeller

✓ The notes and steps stated in (⇒ Section 7.4.1, Page 45) to (⇒ Section 7.4.5, Page 47) have been observed/carried out.

✓ The back pull-out unit is kept in a clean and level assembly area.

1. Undo impeller nut 920.95 (right-hand thread).
2. Remove impeller 230 with an impeller removal tool.
3. Place impeller 230 on a clean and level surface.
4. Remove key 940.01 from shaft 210.

7.4.7 Removing the mechanical seal



✓ The notes and steps stated in (⇒ Section 7.4.1, Page 45) to (⇒ Section 7.4.6, Page 47) have been observed/carried out.

✓ The back pull-out unit is kept in a clean and level assembly area.

1. Remove shaft sleeve 523 with the rotating assembly of the mechanical seal (primary ring) from shaft 210.
2. Remove the rotating assembly of the mechanical seal (primary ring) from shaft sleeve 523.
3. Undo hexagon nuts 920.01 and 914.22, if any, on drive lantern 341.
4. Remove casing cover 161 from drive lantern 341.
5. Remove the stationary assembly of the mechanical seal (mating ring) from casing cover 161.
6. Remove and dispose of gasket 400.75.

7.5 Reassembling the pump set

7.5.1 General information/Safety regulations

	<p>⚠ DANGER</p> <p>Wrong selection of motor Explosion hazard!</p> <ul style="list-style-type: none"> ▷ Use an original motor or a motor of identical design from the same manufacturer. ▷ The permissible temperature limits at the motor flange and motor shaft must be higher than the temperatures generated by the pump. (Contact KSB for temperatures).
	<p>⚠ WARNING</p> <p>Improper lifting/moving of heavy assemblies or components Personal injury and damage to property!</p> <ul style="list-style-type: none"> ▷ Use suitable transport devices, lifting equipment and lifting tackle to move heavy assemblies or components.
	<p>CAUTION</p> <p>Improper reassembly Damage to the pump!</p> <ul style="list-style-type: none"> ▷ Reassemble the pump (set) in accordance with the general rules of sound engineering practice. ▷ Use original spare parts only.

Sequence Always re-assemble the pump in accordance with the corresponding general assembly drawing or exploded view.

Sealing elements Check O-rings for any damage and replace by new O-rings, if required.
Always use new gaskets. Make sure that new gaskets have the same thickness as the old ones.
Always fit gaskets of asbestos-free materials or graphite without using lubricants (e.g. copper grease, graphite paste).

Assembly adhesives Avoid the use of assembly adhesives, if possible.
Should an assembly adhesive be required after all, use a commercially available contact adhesive (e.g. Pattex) or sealant (e.g. HYLOMAR or Eppe 33).
Only apply adhesive at selected points and in thin layers.
Never use quick-setting adhesives (cyanoacrylate adhesives).
Coat the locating surfaces of the individual components with graphite or similar before reassembly.

Tightening torques For reassembly, tighten all screws and bolts as specified in this manual.

7.5.2 Installing the mechanical seal

Installing the mechanical seal

The following rules must be observed when installing the mechanical seal:

- Work cleanly and accurately.
- Only remove the protective wrapping of the contact faces immediately before installation takes place.
- Prevent any damage to the sealing surfaces or O-rings.
- ✓ The notes and steps stated in (⇒ Section 7.5.1, Page 48) have been observed/ carried out.
- ✓ The bearing assembly as well as the individual parts are kept in a clean and level assembly area.
- ✓ All dismantled parts have been cleaned and checked for wear.
- ✓ Any damaged or worn parts have been replaced by original spare parts.
- ✓ The sealing surfaces have been cleaned.
 1. Clean shaft sleeve 523, and touch up any score marks or scratches with a polishing cloth, if necessary.
If score marks or scratches are still visible, fit new shaft sleeve 523.
 2. Slide shaft sleeve 523 with new gasket 400.75 onto shaft 210.
 3. Clean the mating ring location in casing cover 161.

	CAUTION
	<p>Elastomers in contact with oil/grease Shaft seal failure!</p> <ul style="list-style-type: none"> ▷ Use water as assembly lubricant. ▷ Never use oil or grease as assembly lubricant.

4. Carefully insert the mating ring. Make sure to apply pressure evenly.
5. **On variants with a bolted casing cover** undo forcing screws 901.31 without removing them.
6. Place casing cover 161 into the locating fit of drive lantern 341.
7. Fit and tighten hexagon nuts 920.01 and/or 920.15, if any.

	NOTE
	<p>To reduce friction forces when assembling the seal, wet the shaft sleeve and the location of the stationary ring with water.</p>

8. Fit the rotating assembly of the mechanical seal (primary ring) on shaft sleeve 523.

Observe the following installation dimension b for mechanical seals with installation length L_{ik} to EN 12756 (design KU):

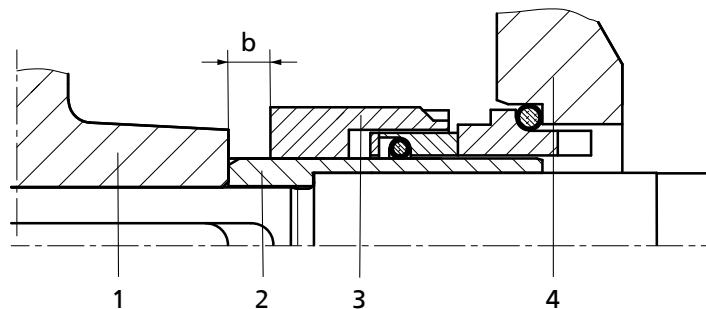

Fig. 10: Installation dimension b of mechanical seal

1	Impeller	2	Shaft sleeve
3	Mechanical seal	4	Casing cover

Table 18: Installation dimensions of the mechanical seal

Shaft unit ⁵⁾	Installation dimension b
25	7,5 mm
35	10 mm
55	15 mm

7.5.3 Fitting the impeller

- ✓ The notes and steps stated in (⇒ Section 7.5.1, Page 48) to (⇒ Section 7.5.2, Page 49) have been observed/carried out.
- ✓ The pre-assembled unit (motor, shaft, drive lantern, casing cover) as well as the individual parts have been placed in a clean and level assembly area.
- ✓ All dismantled parts have been cleaned and checked for wear.
- ✓ Any damaged or worn parts have been replaced by original spare parts.
- ✓ The sealing surfaces have been cleaned.
 1. Insert key 940.01 and slide impeller 230 onto shaft 210.
 2. Fasten impeller nut 920.95, safety device 930.95 and disc 550.95, if any. Observe the tightening torques. (⇒ Section 7.6, Page 52)

7.5.4 Installing the back pull-out unit

	WARNING
	<p>Back pull-out unit tilting Risk of squashing hands and feet!</p> <p>▷ Suspend or support the back pull-out unit at the pump end.</p>

- ✓ The notes and steps stated in (⇒ Section 7.5.1, Page 48) to (⇒ Section 7.5.3, Page 50) have been observed/carried out.
- ✓ Any damaged or worn parts have been replaced by original spare parts.
- ✓ The sealing surfaces have been cleaned.
 1. If required, suspend or support the back pull-out unit to prevent it from tipping over.
 2. Fit new gasket 400.10 into the recess of volute casing 102.
 3. **On variants with a bolted casing cover** undo forcing screws 901.31 without removing them.
 4. Insert the back pull-out unit into volute casing 102.
 5. Depending on the pump size and motor size, fit support foot 183.
 6. Tighten hexagon nut 920.15 (on variant with a bolted casing cover) or 920.01 (on variant with a clamped casing cover) at volute casing 102.

7.5.5 Mounting the motor

	DANGER
	<p>Incorrect shaft connection Explosion hazard!</p> <p>▷ Connect the shafts between pump and motor as described in this manual.</p>

5) Shaft unit see data sheet.

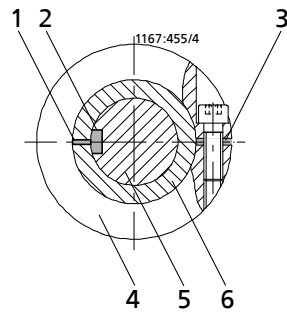
Fig. 11: Fitting the motor shaft stub on the shaft

1	Shaft slot	2	Keyway of the motor shaft end
3	Slot of the taper lock ring	4	Taper lock ring
5	Motor shaft	6	Shaft

✓ The notes and steps stated in (⇒ Section 7.5.1, Page 48) to (⇒ Section 7.5.4, Page 50) have been observed/carried out.

1. Fit the motor shaft stub on shaft 210 and make sure that the keyway of the motor shaft end aligns with the slot in shaft 210 and that both are located opposite the slot of taper lock ring 515 (see illustration: Fitting the motor shaft stub on the shaft).
2. Tighten hexagon socket head cap screws 914.24.
3. Undo hexagon head bolts 901.50.

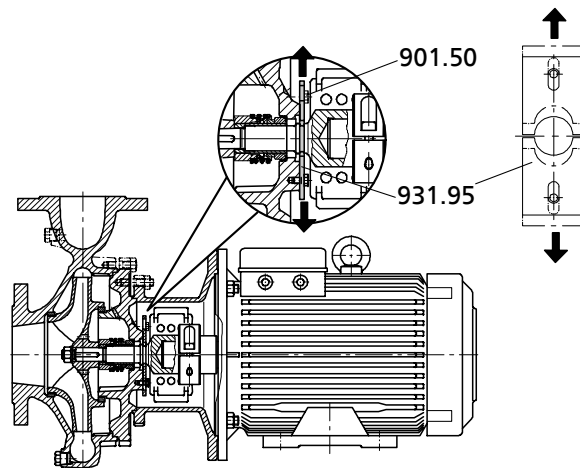
Fig. 12: Removing the lock washers

901.50	Hexagon head bolts	931.95	Lock washer
--------	--------------------	--------	-------------

4. Pull both lock washers 931.95 out of the groove in shaft 210.
5. Tighten hexagon head bolts 901.50.
6. Fit and tighten hexagon nuts 920.11.

7.6 Tightening torques

Table 19: Tightening points

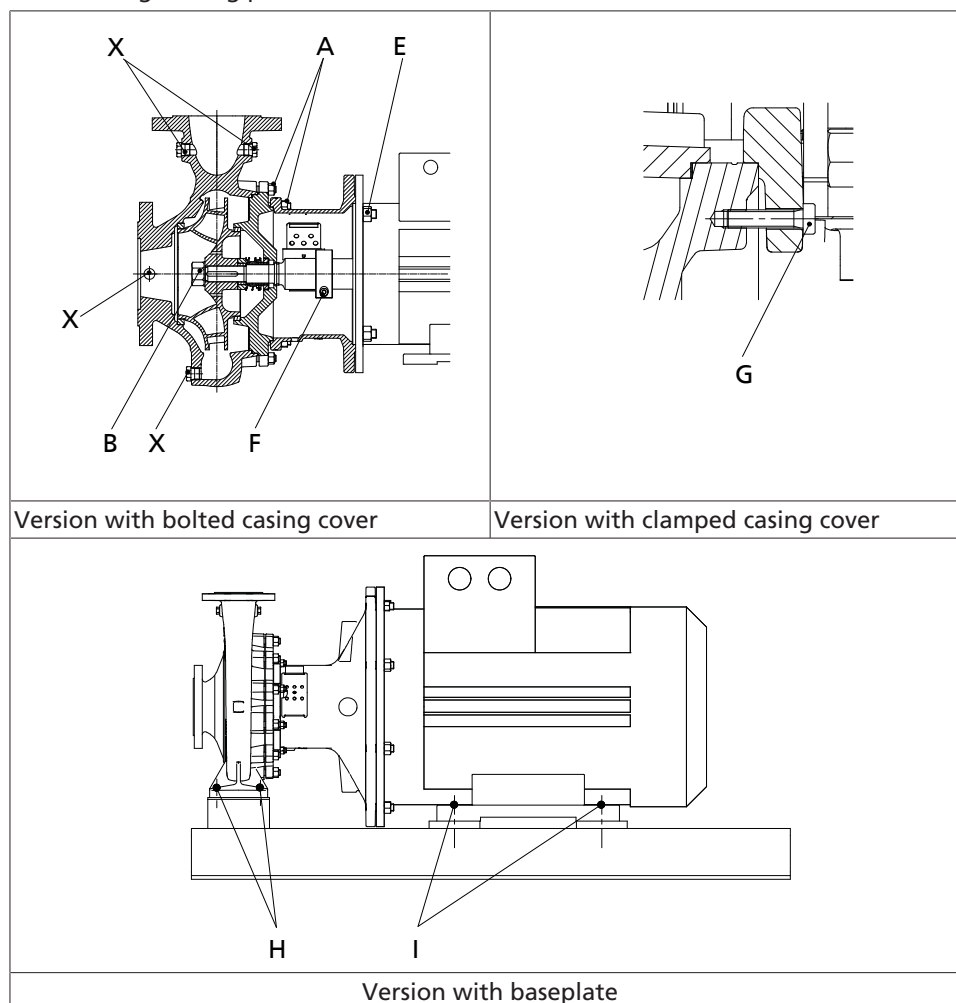

Table 20: Tightening torques for bolted/screwed connections at the pump

Position	Thread	Tightening torque
		[Nm]
A	M12	55
	M16	130
B	M12 × 1,5	55
	M24 × 1,5	130
	M30 × 1,5	170
E	M8	20
	M10	38
	M12	55
	M16	130
F	M6	15
	M8	38
	M10	85
	M12	91
G	M6	5
H	M12	30
	M16	75
	M20	75
I	M20	140

Position	Thread	Tightening torque
		[Nm]
I	M24	140
X	1/8	25
	1/4	55
	3/8	80
	1/2	130
	3/4	220

7.7 Spare parts stock

7.7.1 Ordering spare parts

Always quote the following data when ordering replacement or spare parts:

- Order number
- Order item number
- Consecutive number
- Type series
- Size
- Material variant
- Seal code
- Year of construction

Refer to the name plate for all data.

Also specify the following data:

- Part number and description (⇒ Section 9.1, Page 57)
- Quantity of spare parts
- Shipping address
- Mode of dispatch (freight, mail, express freight, air freight)

7.7.2 Recommended spare parts stock

Table 21: Quantity of spare parts for recommended spare parts stock for commissioning

Part No.	Description	Number of pumps									
		1	2	3	4	5	6	7	8	9	10 and more
433	Mechanical seal	1	1	1	2	2	2	2	3	3	25 %
433.01/02	Mechanical seal ⁶⁾	1	1	1	2	2	2	2	3	3	25 %
400.10	Gasket	2	4	6	8	8	9	9	12	12	150 %
400.75	Gasket	2	4	6	8	8	9	9	12	12	150 %
400.15	Gasket ⁶⁾	2	4	6	8	8	9	9	12	12	150 %
411.15	Joint ring ⁶⁾	2	4	6	8	8	9	9	12	12	150 %
412.15	O-ring ⁶⁾	2	4	6	8	8	9	9	12	12	150 %

Table 22: Quantity of spare parts for recommended spare parts stock for 2 years' operation to DIN 24296

Part No.	Description	Number of pumps									
		1	2	3	4	5	6	7	8	9	10 and more
210	Shaft	1	1	1	1	2	2	2	2	2	20 %
230	Impeller	1	1	1	1	2	2	2	2	2	20 %

6) For double mechanical seal

Part No.	Description	Number of pumps									
		1	2	3	4	5	6	7	8	9	10 and more
433	Mechanical seal	1	1	1	2	2	2	2	3	3	25 %
433.01/.02	Mechanical seal ⁶⁾	1	1	1	2	2	2	2	3	3	25 %
502.01/.02	Casing wear ring ⁷⁾ (set)	1	2	2	2	3	3	3	4	4	50 %
523	Shaft sleeve	1	2	2	2	3	3	3	4	4	50 %
400.10	Gasket	2	4	6	8	8	9	9	12	12	150 %
400.75	Gasket	2	4	6	8	8	9	9	12	12	150 %
400.15	Gasket ⁶⁾	2	4	6	8	8	9	9	12	12	150 %
411.15	Joint ring ⁶⁾	2	4	6	8	8	9	9	12	12	150 %
412.15	O-ring ⁶⁾	2	4	6	8	8	9	9	12	12	150 %

7) If any

8 Trouble-shooting

	WARNING
	<p>Improper work to remedy faults Risk of injury!</p> <p>▷ For any work performed to remedy faults, observe the relevant information given in this instruction manual and/or in the product literature provided by the accessories manufacturer.</p>

If problems occur that are not described in the following table, consultation with KSB Service is required.

- A Pump delivers insufficient flow rate
- B Motor is overloaded
- C Excessive discharge pressure
- D Increased bearing temperature
- E Leakage at the pump
- F Excessive leakage at the shaft seal
- G Vibrations during pump operation
- H Impermissible temperature increase in the pump

Table 23: Trouble-shooting

A	B	C	D	E	F	G	H	Possible cause	Remedy ⁸⁾
X	-	-	-	-	-	-	-	Pump delivers against an excessively high pressure.	Re-adjust to duty point. Check system for impurities. Fit a larger impeller. ⁹⁾ Increase the speed (turbine, I.C. engine).
X	-	-	-	-	-	X	X	Pump or piping are not completely vented or primed.	Vent and/or prime.
X	-	-	-	-	-	-	-	Supply line or impeller clogged	Remove deposits in the pump and/or piping.
X	-	-	-	-	-	-	-	Formation of air pockets in the piping	Alter piping layout. Fit vent valve.
X	-	-	-	-	-	X	X	Suction lift is too high/NPSHavailable (positive suction head) is too low.	Check/alter fluid level. Install pump at a lower level. Fully open the shut-off element in the suction line. Change suction line, if the friction losses in the suction line are too high. Check any strainers installed/suction opening. Observe permissible speed of pressure fall.
X	-	-	-	-	-	-	-	Air intake at the shaft seal	Supply external barrier fluid, if necessary, or increase barrier fluid pressure. Replace shaft seal.
X	-	-	-	-	-	-	-	Wrong direction of rotation	Check the electrical connection of the motor and the control system, if any.
X	-	-	-	-	-	-	-	Speed is too low. - Operation with frequency inverter - Operation without frequency inverter	- Increase voltage/frequency at the FI in the permissible range. - Check voltage.
X	-	-	-	-	-	X	-	Wear of internal components	Replace worn components by new ones.
-	X	-	-	-	-	X	-	Pump back pressure is lower than specified in the purchase order.	Re-adjust to duty point. In the case of persistent overloading, turn down impeller. ⁹⁾

8) Pump pressure must be released before attempting to remedy faults on parts which are subjected to pressure.
9) Contact the manufacturer.

A	B	C	D	E	F	G	H	Possible cause	Remedy ⁸⁾
-	X	-	-	-	-	-	-	Density or viscosity of fluid handled higher than stated in purchase order	Contact the manufacturer.
-	-	-	-	-	X	-	-	Use of unsuitable shaft seal materials	Change the material combination. ⁹⁾
-	X	X	-	-	-	-	-	Speed is too high.	Reduce speed. ⁹⁾
-	-	-	-	X	-	-	-	Tie bolts/sealing element defective	Fit new sealing element between volute casing and casing cover. Re-tighten the bolts.
-	-	-	-	-	X	-	-	Worn shaft seal	Fit new shaft seal. Check flushing liquid/barrier fluid.
X	-	-	-	-	X	-	-	Score marks or roughness on shaft protecting sleeve / shaft sleeve	Replace shaft protecting sleeve / shaft sleeve. Fit new shaft seal.
-	-	-	-	-	X	-	-	Dismantle to find out.	Correct. Fit new shaft seal, if required.
-	-	-	-	-	X	-	-	Vibrations during pump operation	Correct suction conditions. Re-align the pump set. Re-balance the impeller. Increase pressure at the pump suction nozzle.
-	-	-	X	-	X	X	-	Pump is warped or sympathetic vibrations in the piping.	Check the piping connections and secure fixing of pump; if required, reduce distances between the pipe clamps. Fix the pipelines using anti-vibration material.
-	-	-	X	-	-	-	-	Increased axial thrust ⁹⁾	Clean balancing holes in the impeller. Replace the casing wear rings.
-	-	-	X	-	-	-	-	Insufficient or excessive quantity of lubricant or unsuitable lubricant.	Top up, reduce or change lubricant.
X	X	-	-	-	-	-	-	Motor is running on two phases only.	Replace the defective fuse. Check the electric cable connections.
-	-	-	-	-	-	X	-	Rotor out of balance	Clean the impeller. Re-balance the impeller.
-	-	-	-	-	-	X	-	Defective bearing(s)	Replace.
-	-	-	X	-	-	X	X	Flow rate is too low.	Increase the minimum flow rate.
-	-	-	-	-	X	-	-	Incorrect inflow of circulation liquid.	Increase the free cross-section.
-	X	X	-	-	-	-	-	Transport lock has not been removed from the shaft groove.	Remove transport lock from the shaft groove.

Part No.	Description	Part No.	Description
400.10/75	Gasket	930.95	Spring washer
411.01/02/03/04/08	Joint ring	931.95	Lock washer
433	Mechanical seal	940.01	Key
502.01/02	Casing wear ring	Connections:	
515	Locking ring	1M	Pressure gauge connection
523	Shaft sleeve	6B	Fluid drain
550.95	Disc	6D	Fluid priming and venting

9.1.2 Pump set with single mechanical seal and clamped casing cover

Table 26: This view applies to the following pump sizes:

40-25-160	50-32-125.1	65-40-125	65-50-125	80-65-125	100-80-160	125-100-160	150-125-200	200-150-200
	50-32-160.1	65-40-160	65-50-160	80-65-160	100-80-200	125-100-200		
	50-32-125							
	50-32-160							

[Supplied in packaging units only

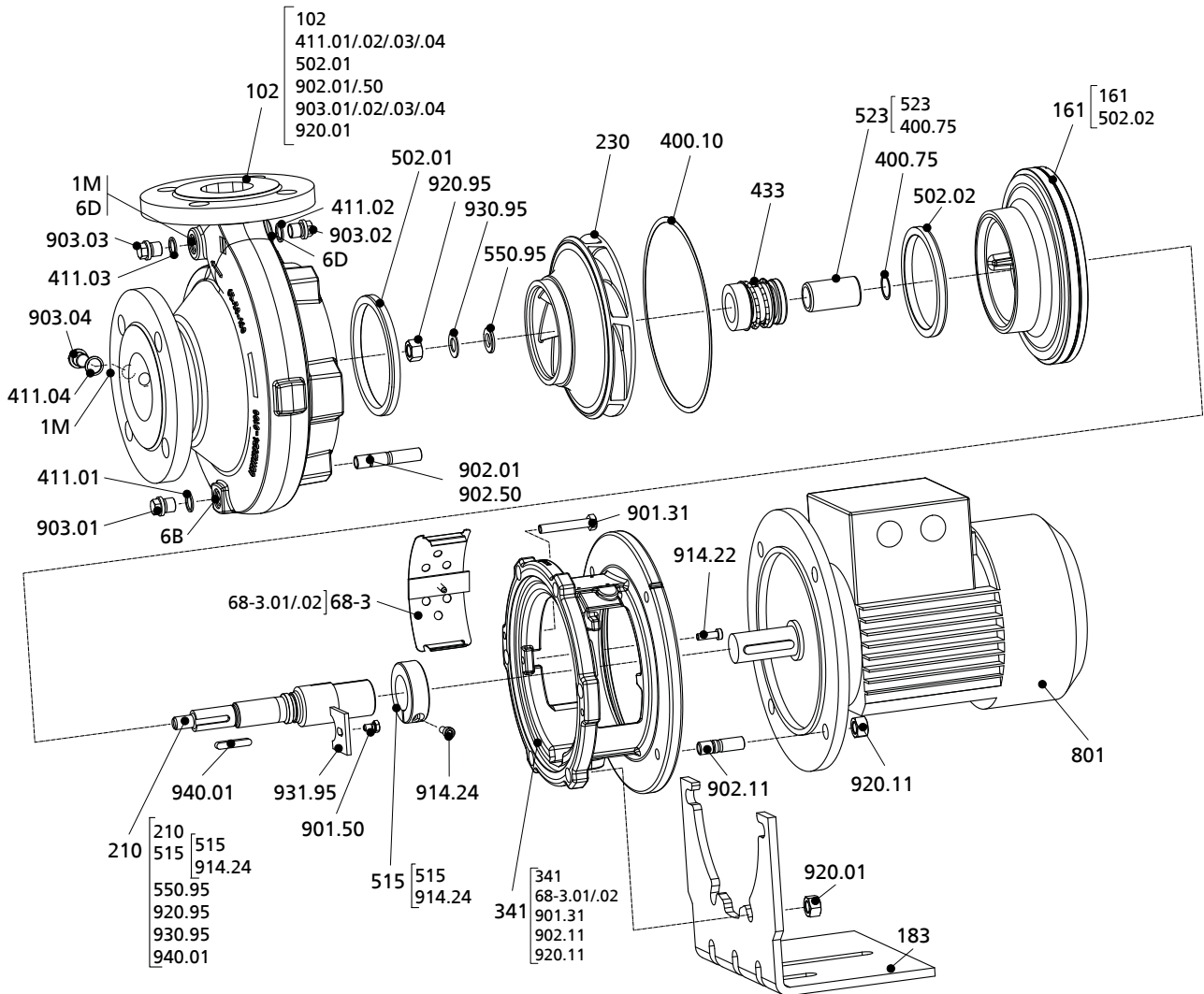

Fig. 14: Pump set with single mechanical seal and clamped casing cover

Table 27: List of components¹²⁾

Part No.	Description	Part No.	Description
102	Volute casing	68-3.01/.02	Cover plate
146	Intermediate lantern	801	Flanged motor
161	Casing cover	901.30/.31/.50	Hexagon head bolt
183	Support foot	902.01/.06/.11/.15/.50/.51	Stud
210	Shaft	903.01/.02/.03/.04/.08	Screw plug
230	Shaft	914.22/.24	Socket head cap screw
341	Drive lantern	920.01/.06/.11/.15/.95	Hexagon nut
400.10/.75	Gasket	930.95	Spring washer
411.01/.02/.03/.04/.08	Joint ring	931.95	Lock washer
433	Mechanical seal	940.01	Key

12) Some individual components might not be applicable, depending on the size and material.

Part No.	Description	Part No.	Description
502.01/02	Casing wear ring	Connections:	
515	Casing wear ring	1M	Pressure gauge connection
523	Shaft sleeve	6B	Fluid drain
550.95	Disc	6D	Fluid priming and venting

9.1.3 Version with double mechanical seal in back-to-back arrangement

Supplied in packaging units only

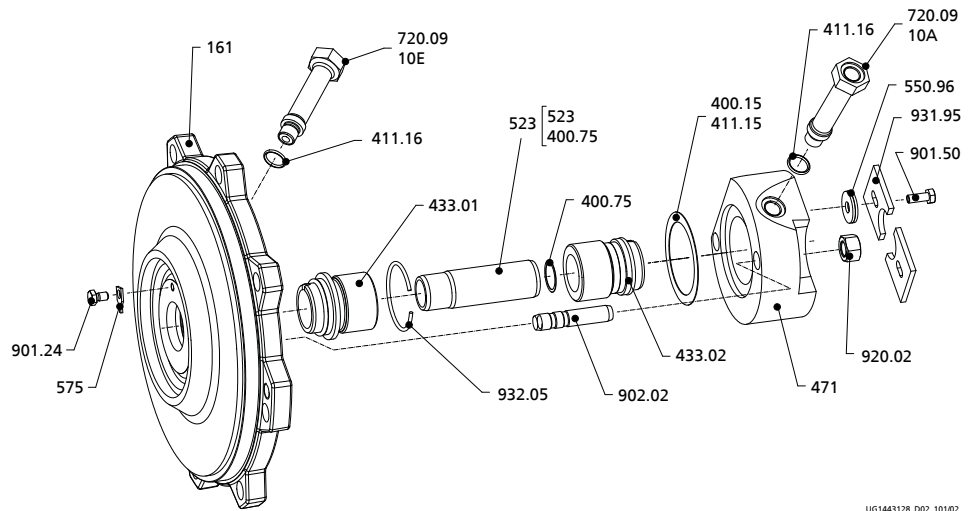

UG1443128_D02_10102

Fig. 15: Version with double mechanical seal in back-to-back arrangement

Table 28: List of components¹³⁾

Part No.	Description	Part No.	Description
161	Casing cover	575	Strip
400.15/.75	Gasket	720.09	Fitting
411.15/.16	Joint ring	901.24/.50	Hexagon head bolt
433.01/.02	Mechanical seal	902.02	Stud
471	Seal cover	920.02	Hexagon nut
523	Shaft sleeve	931.95	Lock washer
550.96	Disc	932.05	Circlip
562.02	Parallel pin		

Table 29: Auxiliary connections

Part No.	Description	Part No.	Description
10A	External barrier water outlet	10E	External barrier water inlet

13) Some individual components might not be applicable, depending on the pump size and material.

9.1.4 Version with double mechanical seal in tandem arrangement

Supplied in packaging units only

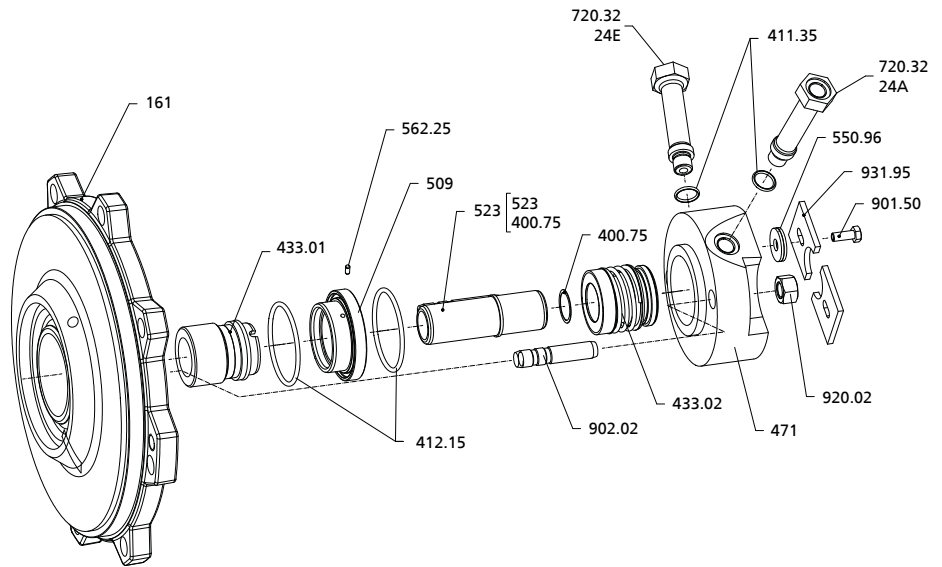

Fig. 16: Version with double mechanical seal in tandem arrangement

UG1443128_D01_10162

Table 30: List of components¹⁴⁾

Part No.	Description	Part No.	Description
161	Casing cover	550.96	Disc
400.75	Gasket	562.25	Parallel pin
411.35	Joint ring	720.32	Fitting
412.15	O-ring	901.50	Hexagon head bolt
433.01/02	Mechanical seal	902.02	Stud
471	Seal cover	920.02	Hexagon nut
509	Intermediate ring	931.95	Lock washer
523	Shaft sleeve		

Table 31: Auxiliary connections

Part No.	Description	Part No.	Description
24A	Quench liquid outlet	24E	Quench liquid inlet

14) Some individual components might not be applicable, depending on the pump size and material.

10 EU Declaration of Conformity

Manufacturer: **KSB SE & Co. KGaA**
Johann-Klein-Straße 9
67227 Frankenthal (Germany)

The manufacturer herewith declares that the product:

Etabloc, Etabloc SYT, Etaline, Etaline SYT, Etaline Z, Etachrom B, Etachrom L, Etanorm, Etanorm SYT, Etanorm V, Etaprime L, Etaprime B, Vitachrom

KSB order number:

- is in conformity with the provisions of the following Directives as amended from time to time:
 - Pump (set): Machinery Directive 2006/42/EC

The manufacturer also declares that

- the following harmonised international standards have been applied:
 - ISO 12100
 - EN 809

Person authorised to compile the technical file:

Name
Function
Address (company)
Address (street, No.)
Address (post or ZIP code, city) (country)

The EU Declaration of Conformity was issued in/on:

Place, date

.....¹⁵⁾.....

Name
Function
Company
Address

15) A signed, legally binding EU Declaration of Conformity is supplied with the product.

Index

A

Applications 8
Automation 19
Auxiliary connections 30

B

Bearing temperature 43

C

Certificate of Decontamination 64
Clearances 44
Commissioning 34
Contact guard 23

D

Design 18, 22
Direction of rotation 33
Dismantling 46
Disposal 14
Drive 18, 23

E

Event of damage 6
 Ordering spare parts 53
Exploded view 57, 59, 61, 62
Explosion protection 10, 31, 32, 34, 35, 37, 41, 42, 44, 50

F

Faults
 Causes and remedies 55
Filter 44
Fluid handled
 Density 38
Frequency of starts 37, 38
Function 22

G

General assembly drawing 57, 59, 61, 62

I

Impeller type 19
Installation 24
 Installation on a foundation 25
Installation at site 24
Intended use 8

K

Key to safety symbols/markings 7

M

Maintenance 42
Mechanical seal 36
Monitoring equipment 11

N

Name plate 18
Noise characteristics 23

O

Operating limits 37
Order number 6
Other applicable documents 6

P

Partly completed machinery 6
Permissible forces at the pump nozzles 27
Piping 26
Preservation 13, 39
Product description 15
Pump casing 18

R

Reassembly 46, 48
Return to supplier 13
Returning to service 39

S

Safety 8
Safety awareness 9
Scope of supply 23
Shaft seal 19
Shutdown 39
Spare part
 Ordering spare parts 53
Spare parts stock 53
Start-up 35
Storage 13, 39

T

Temperature limits 10
Tightening torques 52
Transport 12

W

Warnings 7
Warranty claims 6



KSB SE & Co. KGaA

Johann-Klein-Straße 9 • 67227 Frankenthal (Germany)

Tel. +49 6233 86-0

www.ksb.com

1173.8/06-EN (01561570)