

# TP, TPD

Installation and operating instructions



# English (GB) Installation and operating instructions

## Original installation and operating instructions

### CONTENTS

	Page
<b>1. Symbols used in this document</b>	<b>2</b>
<b>2. General information</b>	<b>2</b>
<b>3. Delivery and handling</b>	<b>3</b>
3.1 Delivery	3
3.2 Handling	3
<b>4. Applications</b>	<b>4</b>
4.1 Pumped liquids	4
<b>5. Installation</b>	<b>4</b>
5.1 Pipework	6
5.2 Elimination of noise and vibrations	6
5.3 Foundation	7
5.4 Terminal box positions	8
5.5 Base plate	8
5.6 Insulation	8
5.7 Frost protection	8
<b>6. Electrical connection</b>	<b>9</b>
6.1 Frequency converter operation	9
<b>7. Startup</b>	<b>10</b>
7.1 Flushing the pipe system	10
7.2 Priming	10
7.3 Checking the direction of rotation	10
7.4 Starting	11
7.5 Shaft seal run-in	11
7.6 Frequency of starts and stops	11
<b>8. Maintenance and service</b>	<b>11</b>
8.1 Pump	11
8.2 Motor	12
8.3 Service	12
8.4 Adjusting the shaft	12
8.5 Blanking flanges	13
<b>9. Technical data</b>	<b>13</b>
9.1 Ambient temperature	13
9.2 Liquid temperature	13
9.3 Operating pressure/test pressure	13
9.4 Inlet pressure	13
9.5 Enclosure class	13
9.6 Electrical data	13
9.7 Sound pressure level	13
9.8 Environment	13
<b>10. Fault finding the product</b>	<b>14</b>
<b>11. Disposal</b>	<b>15</b>

#### Warning



Prior to installation, read these installation and operating instructions. Installation and operation must comply with local regulations and accepted codes of good practice.

## 1. Symbols used in this document

#### Warning



If these safety instructions are not observed, it may result in personal injury.



If these safety instructions are not observed, it may result in malfunction or damage to the equipment.



Notes or instructions that make the job easier and ensure safe operation.

## 2. General information

These instructions apply to the pump types TP and TPD fitted with Grundfos motors. If the pump is fitted with another motor make, please note that the motor data may differ from the data stated in these instructions.

### 3. Delivery and handling

#### 3.1 Delivery

The pump is delivered from the factory in a carton with a wooden bottom, which is specially designed for transport by fork-lift truck or a similar vehicle.

#### 3.2 Handling

**Warning**

The lifting eyes fitted to large pump motors can be used for lifting the pump head (motor, motor stool and impeller). The lifting eyes must not be used for lifting the entire pump.



TPD:

The centrally positioned thread of the pump housing must not be used for lifting purposes as the thread is placed below the centre of gravity of the pump.

Pumps without lifting eyes must be lifted by means of nylon straps. See figures 1 and 2.

Pumps with lifting eyes must be lifted by means of nylon straps and shackles. See figures 3 and 4.

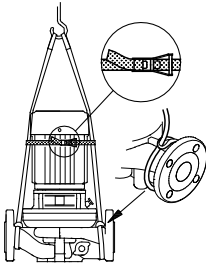

Fig. 1 TP

TM02 7007 2303

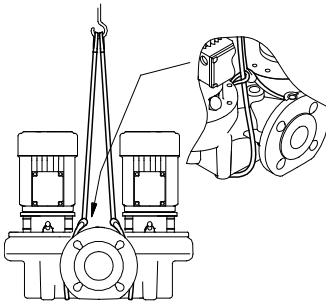

Fig. 2 TPD

TM02 7008 2303

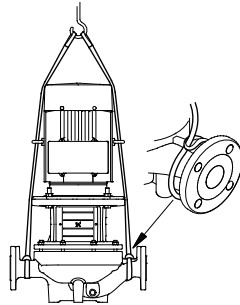

Fig. 3 TP

TM02 7009 2303

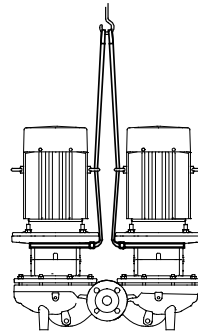

Fig. 4 TPD

TM02 7010 2303

## 4. Applications

The pumps are designed to circulate hot or cold water in residential, institutional and industrial applications in systems, such as:

- heating systems
- district heating plants
- central heating systems for blocks of flats
- air-conditioning systems
- cooling systems.

In addition, the pump range is used for liquid transfer and water supply in systems such as:

- washing systems
- domestic hot water systems
- industrial systems in general.

To ensure optimum operation, the dimensioning range of the system must fall within the performance range of the pump.

### 4.1 Pumped liquids

Thin, clean, non-aggressive and non-explosive liquids, not containing solid particles or fibres that may attack the pump mechanically or chemically.

Examples:

- Central heating system water (the water must meet the requirements of accepted standards on water quality in heating systems)
- cooling liquids
- domestic hot water
- industrial liquids
- softened water.

The pumping of liquids with a density and/or kinematic viscosity higher than that of water will have the following effects:

- a considerable pressure drop
- a drop in hydraulic performance
- a rise in power consumption.

In such cases, the pump must be fitted with a bigger motor. If in doubt, contact Grundfos.

The EPDM O-rings fitted as standard are primarily suitable for water.

If the water contains mineral/synthetic oils or chemicals or if other liquids than water are pumped, the O-rings must be chosen accordingly.

## 5. Installation



### Warning

When pumping hot or cold liquids, make sure that persons cannot accidentally come into contact with hot or cold surfaces.

The pump must be sited in a dry, well ventilated, but frost-free position.

When installing pumps with oval bolt holes in the pump flange (PN 6/10), use washers as shown in fig. 5.

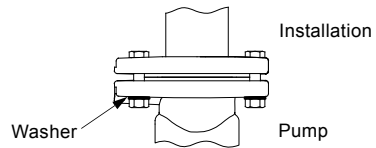

Fig. 5 Use of washers for oval bolt holes

Arrows on the pump housing show the direction of flow of liquid through the pump.

Pumps with motors smaller than 11 kW can be installed in horizontal or vertical pipework.

Pumps with motors of 11 kW and up may only be installed in horizontal pipework with the motor in vertical position.

However, some TP, TPE pumps of 11 kW and up may be suspended directly in the pipes (horizontally or vertically). See the table *TP, TPE pumps from 11 kW and up suspended in the pipes* on page 29.

In installations where the pump is suspended directly in the pipes, the pump can support the pipe length L on both sides of the pump (L less than 3 x DN). See fig. 6. In installations where the pump is suspended directly in the pipes, the pump must be lifted and held in correct position by means of ropes or similar until both pump flanges are completely fastened to the pipe flanges.

### Vertical pipe

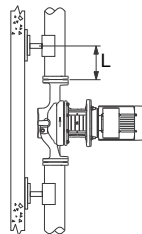

### Horizontal pipe

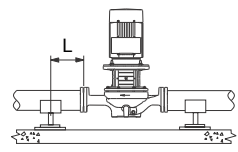

Fig. 6 Pump suspended directly in the pipes

TM01 0683 1997

TM06 3518 0615

**Caution** The motor must never fall below the horizontal plane.

For inspection and motor/pump head removal, the following clearance is required above the motor:

- 300 mm for motors up to and including 4.0 kW.
- 1 m for motors of 5.5 kW and up.

See fig. 7.

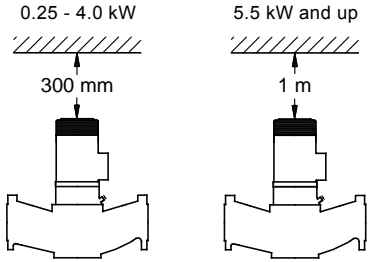

**Fig. 7** Required clearance above the motor

Twin-head pumps installed in horizontal pipes must be fitted with an automatic air vent in the upper part of the pump housing. See fig. 8. The automatic air vent is not supplied with the pump.

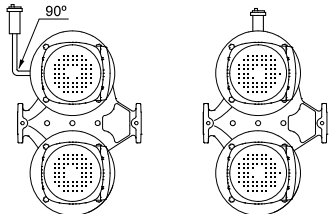

**Fig. 8** Automatic air vent

If the liquid temperature falls below the ambient temperature, condensation may form in the motor during inactivity. In this case, make sure that the drain hole in the motor flange is open and points downwards. See fig. 9.

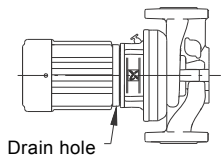

**Fig. 9** Drain hole in motor flange

If twin-head pumps are used for pumping liquids with a temperature below 0 °C / 32 °F, condensed water may freeze and cause the coupling to get stuck. The problem can be remedied by installing heating elements. Whenever possible (pumps with motors smaller than 11 kW), the pump must be installed with the motor shaft in horizontal position. See fig. 8.

**Caution** The technical data in section 9. *Technical data* must be observed.

TM00 3733 2802

TM03 8127 0507

TM00 9831 4715

## 5.1 Pipework

Fit isolating valves on either side of the pump to avoid draining the system if the pump needs to be cleaned or repaired.

The pump is suitable for pipeline mounting, provided that the pipework is adequately supported either side of the pump. TP 25-50, 25-80, 25-90, 32-50, 32-80, 32-90, 40-50, 40-80 and 40-90 are designed for pipeline mounting only.

When installing the pipes, make sure that the pump housing is not stressed by the pipework.

The inlet and outlet pipes must be of an adequate size, taking the pump inlet pressure into account.

To avoid sediment build-up, do not fit the pump at the lowest point of the system.

Install the pipes so that air locks are avoided, especially on the inlet side of the pump. See fig. 10.

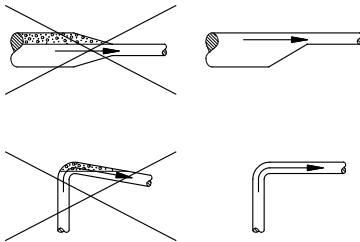

**Fig. 10** Correct pipework on the inlet side of the pump

### Caution

The pump is not allowed to run against a closed outlet valve as this will cause an increase in temperature/formation of steam in the pump which may cause damage to the pump.

If there is any danger of the pump running against a closed outlet valve, ensure a minimum liquid flow through the pump by connecting a bypass/a drain to the outlet pipe. The drain can for instance be connected to a tank. A minimum flow rate equal to 10 % of the flow rate at maximum efficiency is needed at all times.

Flow rate and head at maximum efficiency are stated on the pump nameplate.

## 5.2 Elimination of noise and vibrations

In order to achieve optimum operation and minimum noise and vibration, consider vibration damping of the pump. Generally, always consider this for pumps with motors of 11 kW and up, but for motors of 90 kW and up as well as the pumps stated in the table below, vibration damping is mandatory:

Pump type	P2 [kW]	Frequency [Hz]
TP 200-280/4	37	60
TP 200-290/4	37	50
TP 200-320/4	45	60
TP 200-360/4	55	60
TP 200-390/4	75	60

Smaller motor sizes, however, may also cause undesirable noise and vibration.

Noise and vibration are generated by the revolutions of the motor and pump and by the flow in pipes and fittings. The effect on the environment is subjective and depends on correct installation and the state of the remaining system.

Elimination of noise and vibrations is best achieved by means of a concrete foundation, vibration dampers and expansion joints.

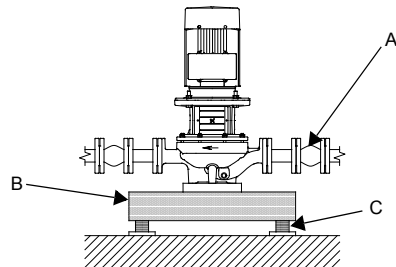

**Fig. 11** Foundation for TP pump

Pos.	Description
A	Expansion joint
B	Concrete pedestal
C	Vibration damper

At high liquid velocities (greater than 5 m/s), we recommend that you fit larger expansion joints matching the pipes.

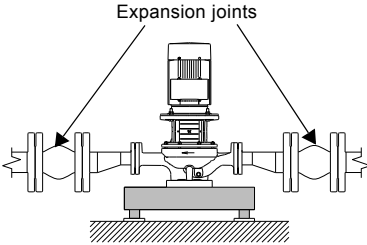

**Fig. 12** TP pump installed with larger expansion joints

TM04 9629 4810

### 5.3 Foundation

We recommend that you install the pump on a concrete foundation which is heavy enough to provide permanent and rigid support to the entire pump. The foundation must be capable of absorbing any vibration, normal strain or shock. As a rule of thumb, the weight of the concrete foundation must be 1.5 times the weight of the pump. Place the pump on the foundation and fasten it. See fig. 11.

#### 5.3.1 Recommended concrete foundations for TP, TPD Series 300 pumps

For TP Series 300 pumps with weights of 150 kg or more, we recommend that you mount the pump on a concrete foundation with the dimensions stated in the table below. The same recommendation applies for TPD Series 300 pumps with weights of 300 kg or more.

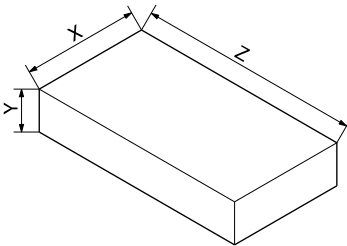

**Fig. 13** Foundation for TP, TPD Series 300 pumps

TM03 9190 3607

Concrete foundation dimensions			
Pump weight [kg]	Y (height) [mm]	Z (length) [mm]	X (width) [mm]
150	280	565	565
200	310	620	620
250	330	670	670
300	360	710	710
350	375	750	750
400	390	780	780
450	410	810	810
500	420	840	840
550	440	870	870
600	450	900	900
650	460	920	920
700	470	940	940
750	480	970	970
800	490	990	990
850	500	1010	1010
900	510	1030	1030
950	520	1050	1050
1000	530	1060	1060
1050	540	1080	1080
1100	550	1100	1100
1150	560	1100	1100
1200	560	1130	1130
1250	570	1150	1150
1300	580	1160	1160
1350	590	1180	1180
1400	600	1190	1190
1450	600	1200	1200
1500	610	1220	1220
1550	620	1230	1230
1600	620	1250	1250
1650	630	1250	1250
1700	635	1270	1270

≤ DN 200

## Concrete foundation dimensions

Pump weight [kg]	Y (height) [mm]	Z (length) [mm]	X (width) [mm]	
800	450	1400	800	
1000	450	1400	1000	
1200	450	1400	1200	
1400	500	1600	1200	
1600	500	1600	1350	
1800	500	1600	1500	
2000	550	1600	1600	
2200	550	1700	1700	
2400	DN 300 / DN 350 / DN 400	550	1800	1800
2600		600	1800	1800
3000		600	2000	2000
3400		680	2000	2000
3800		760	2000	2000
4200		840	2000	2000
4600		920	2000	2000
5000		1000	2000	2000
5400		1080	2000	2000

## 5.4 Terminal box positions

## Warning



Before starting work on the pump, make sure that the power supply has been switched off and that it cannot be accidentally switched on.

The terminal box can be turned to any of four positions, in 90 ° steps.

Change the terminal box position as follows:

1. If necessary, remove the coupling guards using a screwdriver. Do not remove the coupling.
2. Remove the screws securing the motor to the pump.
3. Turn the motor to the required position.
4. Replace and tighten the screws.
5. Replace the coupling guards.

## 5.5 Base plate

Single-head pumps (except TP 25-50, 25-80, 25-90, 32-50, 32-80, 32-90, 40-50, 40-80 and 40-90) have two tapped holes in the bottom of the pump housing which can be used for fitting a Grundfos base plate to the pump. The base plate is available as an optional extra.

Twin-head pumps have four tapped holes in the bottom of the pump housing. For some twin-head pumps, a base plate consisting of two halves is available.

Base plates with dimensions are shown on page 32.

## 5.6 Insulation

Do not insulate the motor stool as this will trap any vapour escaping from the shaft seal, thus causing corrosion. Covering the motor stool with insulation will also make inspection and service difficult.

Follow the guidelines in fig. 14 when insulating the pump.

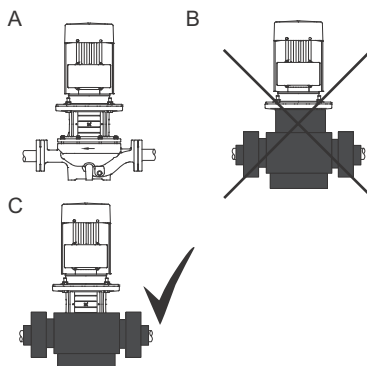

Fig. 14 Insulation of TP pumps

Pos.	Description
A	Without insulation
B	Incorrect insulation
C	Correct insulation

## 5.7 Frost protection

Pumps which are not being used during periods of frost must be drained to avoid damage.



## 6. Electrical connection

Make the electrical connection in accordance with local regulations.

### Warning



Before removing the terminal box cover and before any removal/dismantling of the pump, make sure that the power supply has been switched off.

Connect the pump to an external mains switch with a minimum contact gap of 3 mm in all poles.

The operating voltage and frequency are marked on the pump nameplate. Make sure that the motor is suitable for the power supply on which it will be used.

Single-phase standard motors incorporate a thermal switch and require no additional motor protection.

Three-phase motors must be connected to a motor protection device.

Motors of 3 kW and up incorporate thermistors (PTC). The thermistors are designed according to DIN 44082.

Make the electrical connection as shown in the diagram inside the terminal box cover.

The motors of twin-head pumps are to be connected separately.

### Caution

Do not start the pump until it has been filled with liquid and vented.

## 6.1 Frequency converter operation

Motors types Siemens, MG 71 and MG 80 for supply voltages up to and including 440 V (see motor nameplate) must be protected against voltage peaks higher than 650 V between the supply terminals.

### Caution

### Grundfos motors

All three-phase Grundfos motors from frame size 90 and up can be connected to a frequency converter.

The connection of a frequency converter will often have the effect that the motor insulation system is loaded more and that the motor will be more noisy than during normal operation. In addition, large motors are more at risk of being loaded with bearing currents caused by the frequency converter.

In the case of frequency converter operation, consider the following:

- In 2-pole motors from 45 kW, 4-pole motors from 30 kW and 6-pole motors from 22 kW, one of the motor bearings must be electrically insulated to prevent damaging currents from passing through the motor bearings.
- In the case of noise-critical applications, the motor noise can be reduced by fitting an output filter between the motor and the frequency converter. In particularly noise-critical applications, we recommend that you fit a sinusoidal filter.
- The length of the cable between motor and frequency converter affects the motor load. Therefore, check that the cable length meets the specifications laid down by the frequency converter supplier. For supply voltages between 500 and 690 V, either fit a sinusoidal filter to reduce voltage peaks or use a motor with reinforced insulation.
- For supply voltages of 690 V, use a motor with reinforced insulation and fit a sinusoidal filter.

Grundfos MG motors do not have reinforced insulation. When it comes to reinforced insulation, other motor suppliers are able to supply such motors as FPV variants.

### Note

### 6.1.1 Other motor makes than Grundfos

Contact Grundfos or the motor manufacturer.

## 7. Startup

### 7.1 Flushing the pipe system

The pump is not designed to pump liquids containing solid particles such as pipe debris and welding slag. Before starting up the pump, the pipe system must be thoroughly cleaned, flushed and filled with clean water.

**Caution**

The warranty does not cover any damage caused by flushing the pipe system by means of the pump.

### 7.2 Priming

Do not start the pump until it has been filled with liquid and vented. To ensure correct venting, the vent screw must point upwards.

**Caution**

#### Closed systems or open systems where the liquid level is above the pump inlet:

1. Close the isolating valve on the outlet side and loosen the vent screw in the motor stool. See fig. 15.

**Warning**

Pay attention to the direction of the vent hole and make sure that the escaping liquid does not cause injury to persons or damage to the motor or other components. In hot-liquid installations, pay special attention to the risk of injury caused by scalding hot liquid.



In cold-liquid installations, pay special attention to the risk of injury caused by the cold liquid.

2. Slowly open the isolating valve on the inlet side until a steady stream of liquid runs out of the vent hole.
3. Tighten the vent screw and completely open the isolating valve(s).

#### Open systems where the liquid level is below the pump inlet

The inlet pipe and the pump must be filled with liquid and vented before the pump is started.

1. Close the isolating valve on the outlet side and open the isolating valve on the inlet side.
2. Loosen the vent screw. See fig. 15.
3. Remove the plug from one of the pump flanges, depending on the pump location.
4. Pour liquid through the priming hole until the inlet pipe and the pump are filled with liquid.
5. Replace the plug and tighten securely.
6. Tighten the vent screw.

The inlet pipe can to some extent be filled with liquid and vented before it is connected to the pump. A priming device can also be installed before the pump.

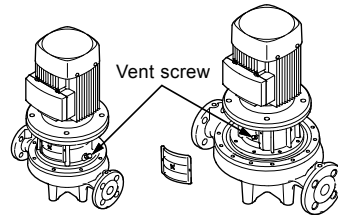

**Fig. 15** Position of vent screw

### 7.3 Checking the direction of rotation

Do not start the pump to check the direction of rotation until it has been filled with liquid.

**Note**

Do not check the direction of rotation with the motor alone, as an adjustment of the shaft position is required when the coupling has been removed.

The correct direction of rotation is shown by arrows on the motor fan cover or on the pump housing.

TM03 8126 0507

## 7.4 Starting

1. Before starting the pump, completely open the isolating valve on the inlet side of the pump and leave the isolating valve on the outlet side almost closed.
2. Start the pump.
3. Vent the pump during starting by loosening the vent screw in the motor stool until a steady stream of liquid runs out of the vent hole. See fig. 15.

### Warning

Pay attention to the direction of the vent hole and make sure that the escaping liquid does not cause injury to persons or damage to the motor or other components.



In hot-liquid installations, pay special attention to the risk of injury caused by scalding hot liquid.

In cold-liquid installations, pay special attention to the risk of injury caused by the cold liquid.

4. When the pipe system has been filled with liquid, slowly open the isolating valve on the outlet side until it is completely open.

## 7.5 Shaft seal run-in

The seal faces are lubricated by the pumped liquid, meaning that there may be a certain amount of leakage from the shaft seal.

When the pump is started up for the first time, or when a new shaft seal is installed, a certain run-in period is required before the leakage is reduced to an acceptable level. The time required for this depends on the operating conditions, i.e. every time the operating conditions change, a new run-in period will be started.

Under normal conditions, the leaking liquid will evaporate. As a result, no leakage will be detected. However, liquids such as kerosene will not evaporate. The leakage may therefore be seen as a shaft seal failure.

## 7.6 Frequency of starts and stops

Frame size	Maximum number of starts per hour		
	Number of poles		
	2	4	6
56-71	100	250	350
80-100	60	140	160
112-132	30	60	80
160-180	15	30	50
200-225	8	15	30
250-315	4	8	12

- On twin-head pumps, the duty and standby pumps must be alternated on a regular basis, i.e. once a week, to ensure an even distribution of the operating hours on both pumps. Pump change can be effected either manually or automatically by installing a suitable pump controller.
- If twin-head pumps are used for pumping domestic hot water, the duty and standby pumps must be alternated on a regular basis, i.e. once a day, to avoid blocking of the standby pump due to deposits (calcareous deposits, etc.). We recommend automatic pump change.

## 8. Maintenance and service

### Warning

Before starting work on the pump, make sure that the power supply has been switched off and that it cannot be accidentally switched on.



Make sure that the escaping liquid does not cause injury to persons or damage to the motor or other components.

In hot-liquid installations, pay special attention to the risk of injury caused by scalding hot liquid.

In cold-liquid installations, pay special attention to the risk of injury caused by the cold liquid.

### 8.1 Pump

The pump is maintenance-free.

If the pump is to be drained for a long period of inactivity, inject a few drops of silicone oil on the shaft between the motor stool and the coupling. This will prevent the shaft seal faces from sticking.

## 8.2 Motor

Check the motor at regular intervals. It is important to keep the motor clean in order to ensure adequate ventilation. If the pump is installed in a dusty environment, both pump and motor must be cleaned and checked regularly.

### Lubrication

The bearings of motors up to 11 kW are greased for life and require no lubrication.

The bearings of motors of 11 kW and up must be greased in accordance with the indications on the motor nameplate.

Lubricate the motor with a lithium-based, high-temperature grease.

- The technical specification of the grease must correspond to DIN 51825, K3N, or better.
- The viscosity of the basic oil must be higher than 50 cSt (mm<sup>2</sup>/s) at 40 °C (104 °F) and 8 cSt (mm<sup>2</sup>/s) at 100 °C (212 °F).
- The grease filling rate must be 30-40 %.

## 8.3 Service



### Warning

If the pump has been used for a liquid which is injurious to health or toxic, the pump will be classified as contaminated.

If Grundfos is requested to service the pump, Grundfos must be contacted with details about the pumped liquid, etc. before the pump is returned for service. Otherwise Grundfos can refuse to accept the pump for service.

Possible costs of returning the pump are paid by the customer.

## 8.4 Adjusting the shaft

If the motor has been removed during installation or for repair of the pump, the pump shaft must be adjusted after the motor has been replaced.

### 8.4.1 Pumps with two-part coupling

#### Pumps Series 100 and 200

Make sure that the shaft pin is fitted in the pump shaft.

Adjust the pump shaft as follows:

1. Remove the coupling guards using a screwdriver.
2. Fit the hexagon socket head screws in the coupling and leave loose.
3. Raise the coupling and the pump shaft as far as possible (towards the motor) with a screwdriver or a similar tool so that the pump and motor shafts touch each other. See fig. 16.

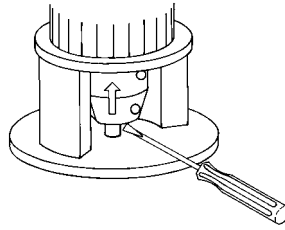

Fig. 16 Raising the coupling and the pump shaft

4. Tighten the hexagon socket head screws in the coupling to 5 Nm (0.5 kpm).
5. Check that the gaps either side of the coupling halves are equal.
6. Tighten the screws two and two (one side at a time) to the torque stated below. See fig. 17.

Hexagon socket head screw	Torque
M6 x 20	13 Nm (1.3 kpm)
M8 x 25	31 Nm (3.1 kpm)

7. Fit the coupling guards.

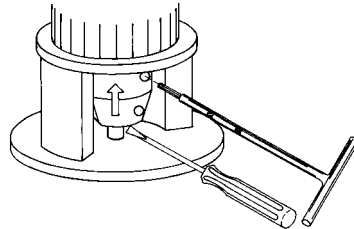

Fig. 17 Tightening the screws

### 8.4.2 Pumps with integral shaft/coupling

For pumps with integral shaft/coupling, we recommend that you do not remove the motor. If the motor has been removed, it is necessary to remove the motor stool in order to refit the motor correctly. Otherwise the shaft seal may be damaged.

## 8.5 Blanking flanges

For twin-head pumps, a blanking flange with a pump housing gasket is available. See fig. 18.

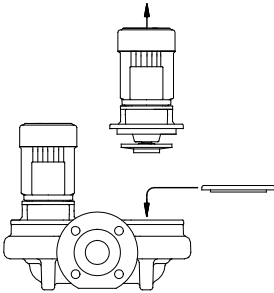

**Fig. 18** Fitting the blanking flange

If one pump requires service, the blanking flange is fitted to allow the other pump to continue operating.

## 9. Technical data

### 9.1 Ambient temperature

Maximum 55 °C (131 °F).

### 9.2 Liquid temperature

-40 - +150 °C (-40 - +302 °F).

The maximum liquid temperature depends on the mechanical shaft seal type and the pump type.

Depending on the cast-iron version and the pump application, the maximum liquid temperature may be limited by local regulations and laws.

The maximum liquid temperature is marked on the pump nameplate.

**Note**

If the pump is operating with liquids at high temperatures, the life of the shaft seal may be reduced. It may be necessary to replace the shaft seal more often.

TM00 6360 3495

## 9.3 Operating pressure/test pressure

The pressure test has been made with water containing anti-corrosive additives at a temperature of 20 °C (68 °F).

Pressure stage	Operating pressure		Test pressure	
	[bar]	[MPa]	[bar]	[MPa]
PN 6	6	0.6	10	1.0
PN 6 / PN 10	10	1.0	15	1.5
PN 16	16	1.6	24	2.4
PN 25	25	2.5	38	3.8

## 9.4 Inlet pressure

To ensure optimum and quiet pump operation, the inlet pressure (system pressure) must be adjusted correctly. See the table on page 16.

For the calculation of specific inlet pressures, contact the local Grundfos company or see the data booklet for TP, TPD, TPE, TPED, TPE2, TPE2 D, TPE3, TPE3 D, if at hand.

## 9.5 Enclosure class

Closed drain hole in motor: IP55.

Open the drain hole in motor: IP44. See fig. 9.

## 9.6 Electrical data

See motor nameplate.

## 9.7 Sound pressure level

### Pumps with single-phase motors

The sound pressure level of the pump is lower than 70 dB(A).

### Pumps with three-phase motors

See the table on page 28.

## 9.8 Environment

Non-aggressive and non-explosive atmosphere.

Relative air humidity: Maximum 95 %.

## 10. Fault finding the product

### Warning

Before removing the terminal box cover and before removal/dismantling the pump, make sure that the power supply has been switched off and that it cannot be accidentally switched on.



Make sure that the escaping liquid does not cause injury to persons or damage to the motor or other components.

In hot-liquid installations, pay special attention to the risk of injury caused by scalding hot liquid.

In cold-liquid installations, pay special attention to the risk of injury caused by the cold liquid.

Fault	Cause
1. Motor does not run when started.	<ul style="list-style-type: none"> <li>a) Power supply failure.</li> <li>b) Fuses blown.</li> <li>c) Motor protection device has tripped.</li> <li>d) Main contacts in motor protection device are not making contact or the coil is faulty.</li> <li>e) Control circuit fuses are defective.</li> <li>f) Motor is defective.</li> </ul>
2. Motor protection device trips immediately when power supply is switched on.	<ul style="list-style-type: none"> <li>a) Power supply failure.</li> <li>b) Contacts in motor protection device are faulty.</li> <li>c) Cable connection is loose or faulty.</li> <li>d) Motor winding is defective.</li> <li>e) Pump is mechanically blocked.</li> <li>f) Overload setting too low.</li> </ul>
3. Motor protection device trips occasionally.	<ul style="list-style-type: none"> <li>a) Overload setting too low.</li> <li>b) Supply voltage periodically too low or too high.</li> <li>c) Differential pressure across pump too low.</li> </ul>
4. Motor protection device has not tripped but the pump does not run.	<ul style="list-style-type: none"> <li>a) Check the power supply.</li> <li>b) Check fuses.</li> <li>c) Check the main contacts in the motor protection device and coil.</li> <li>d) Check the control circuit.</li> </ul>
5. Pump capacity not constant.	<ul style="list-style-type: none"> <li>a) Pump inlet pressure is too low.</li> <li>b) Inlet pipe/pump partly blocked by impurities.</li> <li>c) Pump draws in air.</li> </ul>
6. Pump runs but gives no water.	<ul style="list-style-type: none"> <li>a) Inlet pipe/pump blocked by impurities.</li> <li>b) Foot or non-return valve blocked in closed position.</li> <li>c) Leakage in the inlet pipe.</li> <li>d) Air in inlet pipe or pump.</li> <li>e) Motor rotates in the wrong direction.</li> </ul>
7. Pump runs backwards when switched off.*	<ul style="list-style-type: none"> <li>a) Leakage in the inlet pipe.</li> <li>b) Foot or non-return valve defective.</li> <li>c) Foot or non-return valve blocked in open or partly open position.</li> </ul>
8. Leakage in the shaft seal.	<ul style="list-style-type: none"> <li>a) Pump shaft position is incorrect.</li> <li>b) Shaft seal is defective.</li> </ul>

Fault	Cause
9. Noise.	<ul style="list-style-type: none"> <li>a) Pump is cavitating.</li> <li>b) Pump does not rotate freely (frictional resistance) because of incorrect pump shaft position.</li> <li>c) Frequency converter operation: See section <a href="#">6.1 Frequency converter operation</a>.</li> <li>d) Resonance in the installation.</li> <li>e) Foreign bodies in the pump.</li> </ul>
10. Pump runs constantly (applies only to pumps with automatic start/stop).	<ul style="list-style-type: none"> <li>a) Stop pressure is too high in relation to the required quantity of water.</li> <li>b) The water consumption is larger than anticipated.</li> <li>c) Leakage in the outlet pipe.</li> <li>d) The direction of rotation of the pump is incorrect.</li> <li>e) Pipes, valves or strainer blocked by impurities.</li> <li>f) Pump controller, if used, is defective.</li> </ul>
11. Period of operation is too long (applies only to pumps with automatic start/stop).	<ul style="list-style-type: none"> <li>a) Stop pressure is too high in relation to the required quantity of water.</li> <li>b) Pipes, valves or strainer blocked by impurities.</li> <li>c) Pump partly blocked or seized up.</li> <li>d) The water consumption is larger than anticipated.</li> <li>e) Leakage in the outlet pipe.</li> </ul>

\* In twin-head pump installations, the standby pump will often rotate slowly.

## 11. Disposal

This product or parts of it must be disposed of in an environmentally sound way:

1. Use the public or private waste collection service.
2. If this is not possible, contact the nearest Grundfos company or service workshop.

---

Subject to alterations.

## Appendix

- GB:** Inlet pressure stated in bar relative pressure (pressure gauge value measured on the suction side of the pump)
- BG:** Относително входно налягане в bar (стойност на манометъра в смукателната страна на помпата)
- CZ:** Tlak na sání vyjádřený v barech je relativní tlak (hodnota na manometru měřená na sací straně čerpadla)
- DE:** Zulaufdruck in bar Relativdruck (Manometerdruck auf der Saugseite der Pumpe gemessen)
- DK:** Tilløbstrykket angivet i bar relativt tryk (manometerværdi målt på pumpens sugeside)
- EE:** Rõhk sisendis, antud baarides, on suhteline rõhk (manomeetri näit, mõõdetuna pumba imipoolel)
- ES:** Presión de aspiración indicada en bar como presión relativa (valor del manómetro medido en la aspiración de la bomba)
- FI:** Tulopaine ilmoitettuuna baareina on suhteellinen paine (painemittarin lukema mitattu pumpun imupuolella)
- FR:** Pression d'entrée indiquée en bar (valeur mesurée à l'aide d'un manomètre placé sur le côté aspiration de la pompe)
- GR:** Πίεση αναρρόφησης σε bar σχετικής πίεσης (μετρούμενη τιμή πίεσης στην πλευρά αναρρόφησης της αντλίας)
- HR:** Ulazni tlak u barima relativnog tlaka (manometarski tlak izmjeren na usisnoj strani crpke)
- HU:** Hozzáfolyási nyomás bar-ban, túlnyomás (nyomásmérő mért értéke a szivattyú szívóoldalán)
- IT:** Pressione di aspirazione indicata in bar (valore misurato con un manometro posto sul lato aspirazione della pompa)
- LT:** Manometrinis slėgis įvade bar (manometru matuojama slėgio vertė siurblio įvado pusėje)
- LV:** Ieplūdes spiediens tiek norādīts nosacītas spiediena mērvienības, baros (manometra radījumi tiek mērīti sūkņa sūcpusē)
- NL:** Inlaatdruk weergegeven in bar relatieve druk (drukopnemer waarde, gemeten aan de zuigkant van de pomp)
- PL:** Ciśnienie na króćcu ssawnym pompy wyrażone w barach (mierzone manometrem na stronie ssawnej pompy)
- PT:** Pressão de entrada com a pressão relativa apresentada em bar (ponto de medida na parte de aspiração da bomba)
- RO:** Presiunea de intrare exprimată în bar ca presiune relativă (valoarea măsurată de manometru pe partea de aspirație a pompei)
- RS:** Ulazni pritisak je dat u barima relativnog pritiska (manometarska vrednost merena na usisnoj strani pumpe)
- SE:** Tilloppstrycket angivet i bar relativt tryck (manometervärde mätt på pumpens sugside)
- SI:** Vhodni tlak v barih relativni tlak (izmerjena vrednost na sesalni strani črpalke)
- SK:** Vstupný tlak uvedený v baroch relatívneho tlaku (hodnota na manometru meraná na sacej strane čerpadla)
- AR:** ( ب سحب المضخة ضغط المدخل المذكور بالبار هو ضغط نسبي ) قيمة قياس الضغط المقاسة على جان



50 Hz, 2-pole

Pump type (50 Hz)	p [bar]						
	20 °C	60 °C	90 °C	110 °C	120 °C	140 °C	150 °C
TP 25-50R/2	0.1	0.1	0.2	0.5	-	-	-
TP 25-80R/2	0.1	0.1	0.1	0.3	-	-	-
TP 25-90R/2	0.1	0.1	0.2	0.5	-	-	-
TP 32-50R/2	0.1	0.1	0.1	0.2	-	-	-
TP 32-80R/2	0.1	0.1	0.2	0.5	-	-	-
TP 32-90R/2	0.1	0.1	0.2	0.5	-	-	-
TP, TPD 32-60/2	0.1	0.1	0.2	1.0	1.5	3.2	-
TP, TPD 32-120/2	0.1	0.2	0.7	1.5	2.0	3.7	-
TP, TPD 32-150/2	0.1	0.3	0.8	1.6	2.1	3.8	-
TP, TPD 32-180/2	0.5	0.7	1.2	2.0	2.5	4.2	-
TP, TPD 32-230/2	0.7	0.9	1.4	2.2	2.7	4.4	-
TP, TPD 32-200/2	0.1	0.1	0.2	0.9	1.5	3.1	-
TP, TPD 32-250/2	0.1	0.1	0.3	1.0	1.6	3.2	-
TP, TPD 32-320/2	0.1	0.1	0.6	1.3	1.9	3.5	-
TP, TPD 32-380/2	0.1	0.2	0.7	1.4	2.0	3.6	-
TP, TPD 32-460/2	0.1	0.2	0.7	1.4	1.9	3.6	-
TP, TPD 32-580/2	0.2	0.4	0.9	1.6	2.2	3.8	-
TP 40-50/2	0.1	0.1	0.1	0.3	-	-	-
TP 40-80/2	0.1	0.1	0.2	0.5	-	-	-
TP 40-90/2	0.1	0.1	0.2	0.5	-	-	-
TP, TPD 40-60/2	0.1	0.1	0.5	1.2	1.8	3.5	-
TP, TPD 40-120/2	0.1	0.1	0.4	1.2	1.7	3.4	-
TP 40-180/2	0.1	0.2	0.7	1.5	2.0	3.7	-
TP, TPD 40-190/2	0.1	0.3	0.8	1.6	2.1	3.8	-
TP, TPD 40-230/2	0.7	0.9	1.4	2.2	2.7	4.4	-
TP, TPD 40-270/2	0.7	0.9	1.4	2.2	2.7	4.4	-
TP, TPD 40-240/2	0.1	0.1	0.4	1.1	1.7	3.3	-
TP, TPD 40-300/2	0.1	0.1	0.4	1.1	1.6	3.3	-
TP, TPD 40-360/2	0.2	0.4	0.9	1.6	2.1	3.8	-
TP, TPD 40-430/2	0.1	0.1	0.5	1.2	1.8	3.4	-
TP, TPD 40-530/2	0.1	0.1	0.6	1.3	1.9	3.5	-
TP, TPD 40-630/2	0.1	0.3	0.8	1.5	2.1	3.7	-
TP, TPD 50-60/2	0.1	0.1	0.4	1.1	1.7	3.4	-
TP, TPD 50-120/2	0.1	0.2	0.7	1.5	2.0	3.7	-
TP, TPD 50-180/2	0.1	0.2	0.7	1.4	2.0	3.7	-
TP, TPD 50-160/2	0.1	0.1	0.1	0.8	1.4	3.0	-
TP, TPD 50-190/2	0.1	0.1	0.1	0.8	1.4	3.0	-
TP, TPD 50-240/2	0.1	0.1	0.1	0.8	1.4	3.0	-
TP, TPD 50-290/2	0.1	0.1	0.2	0.9	1.5	3.1	-
TP, TPD 50-360/2	0.1	0.1	0.2	1.0	1.5	3.1	-

Pump type (50 Hz)	p [bar]						
	20 °C	60 °C	90 °C	110 °C	120 °C	140 °C	150 °C
TP, TPD 50-430/2	0.1	0.1	0.4	1.1	1.6	3.3	-
TP, TPD 50-420/2	0.1	0.1	0.3	1.1	1.6	3.2	-
TP, TPD 50-540/2	0.1	0.1	0.5	1.3	1.8	3.4	-
TP, TPD 50-630/2	0.1	0.1	0.6	1.4	1.9	3.6	-
TP, TPD 50-710/2	0.6	0.8	1.3	2.0	2.6	4.2	-
TP, TPD 50-830/2	0.5	0.7	1.2	2.0	2.5	4.1	-
TP, TPD 50-960/2	1.0	1.2	1.7	2.4	3.0	4.6	-
TP, TPD 65-60/2	0.1	0.3	0.8	1.5	2.1	3.8	-
TP, TPD 65-120/2	0.5	0.7	1.2	2.0	2.5	4.2	-
TP, TPD 65-180/2	0.3	0.5	1.0	1.8	2.3	4.0	-
TP, TPD 65-170/2	0.1	0.1	0.1	0.9	1.4	3.1	-
TP, TPD 65-210/2	0.1	0.1	0.2	0.9	1.5	3.1	-
TP, TPD 65-250/2	0.1	0.1	0.3	1.0	1.6	3.2	-
TP, TPD 65-340/2	0.1	0.1	0.2	0.9	1.4	3.1	-
TP, TPD 65-410/2	0.1	0.1	0.2	0.9	1.4	3.1	-
TP, TPD 65-460/2	0.1	0.1	0.2	1.0	1.5	3.1	-
TP, TPD 65-550/2	0.1	0.1	0.3	1.0	1.6	3.2	-
TP, TPD 65-660/2	0.1	0.1	0.4	1.1	1.6	3.3	-
TP, TPD 65-720/2	0.1	0.1	0.6	1.3	1.9	3.5	-
TP, TPD 65-930/2	0.6	0.8	1.3	2.0	2.6	4.2	-
TP, TPD 80-120/2	1.2	1.4	1.9	2.7	3.2	4.9	-
TP, TPD 80-140/2	0.1	0.2	0.7	1.4	1.9	3.6	-
TP, TPD 80-180/2	0.1	0.1	0.3	1.1	1.6	3.2	-
TP, TPD 80-210/2	0.1	0.1	0.4	1.1	1.7	3.3	-
TP, TPD 80-240/2	0.1	0.1	0.5	1.3	1.8	3.4	-
TP, TPD 80-250/2	0.1	0.3	0.8	1.6	2.1	3.7	-
TP, TPD 80-330/2	0.1	0.2	0.7	1.4	2.0	3.6	-
TP, TPD 80-400/2	0.2	0.4	0.9	1.6	2.2	3.8	-
TP, TPD 80-520/2	0.1	0.1	0.6	1.4	1.9	3.5	-
TP, TPD 80-570/2	0.1	0.3	0.8	1.6	2.1	3.7	-
TP, TPD 80-700/2	0.6	0.8	1.3	2.1	2.6	4.2	-
TP, TPD 100-120/2	1.9	2.1	2.6	3.4	3.9	5.6	-
TP, TPD 100-160/2	0.1	0.1	0.6	1.3	1.9	3.5	-
TP, TPD 100-200/2	0.1	0.1	0.4	1.2	1.7	3.3	-
TP, TPD 100-240/2	0.1	0.1	0.5	1.3	1.8	3.4	-
TP, TPD 100-250/2	0.6	0.8	1.3	2.0	2.5	4.2	-
TP, TPD100-310/2	0.6	0.8	1.3	2.0	2.6	4.2	-
TP, TPD 100-360/2	0.6	0.8	1.3	2.0	2.5	4.2	-
TP, TPD 100-390/2	1.0	1.2	1.7	2.4	3.0	4.6	-
TP, TPD 100-480/2	1.5	1.7	2.2	2.9	3.5	5.1	-
TP 100-530/2	1.6	1.8	2.2	3.2	3.7	5.3	6.6

Pump type (50 Hz)	p [bar]						
	20 °C	60 °C	90 °C	110 °C	120 °C	140 °C	150 °C
TP 100-650/2	1.4	1.6	2	3	3.5	5.1	6.4
TP 100-800/2	1.3	1.5	1.9	2.9	3.4	5	6.3
TP 100-950/2	1.3	1.5	1.9	2.9	3.4	5	6.3
TP 100-1040/2	1.2	1.4	1.8	2.8	3.3	4.9	6.2
TP 100-1200/2	1.2	1.4	1.8	2.8	3.3	4.9	6.2
TP 100-1410/2	1.2	1.4	1.8	2.8	3.3	4.9	6.2

## 50 Hz, 4-pole

Pump type (50 Hz)	p [bar]						
	20 °C	60 °C	90 °C	110 °C	120 °C	140 °C	150 °C
TP, TPD 32-30/4	0.1	0.1	0.1	0.8	1.4	3.1	-
TP, TPD 32-40/4	0.1	0.1	0.1	0.9	1.4	3.1	-
TP, TPD 32-60/4	0.1	0.1	0.3	1.1	1.6	3.3	-
TP, TPD 32-80/4	0.1	0.1	0.1	0.5	1.0	2.7	-
TP, TPD 32-100/4	0.1	0.1	0.1	0.5	1.1	2.7	-
TP, TPD 32-120/4	0.1	0.1	0.1	0.6	1.1	2.7	-
TP, TPD 40-30/4	0.1	0.1	0.2	0.9	1.5	3.2	-
TP 40-60/4	0.1	0.1	0.1	0.8	1.4	3.1	-
TP, TPD 40-90/4	0.1	0.1	0.3	1.0	1.6	3.3	-
TP, TPD 40-100/4	0.1	0.1	0.2	0.9	1.5	3.1	-
TP, TPD 40-110/4	0.1	0.1	0.1	0.6	1.2	2.8	-
TP, TPD 40-140/4	0.1	0.1	0.1	0.7	1.3	2.9	-
TP, TPD 50-30/4	0.1	0.1	0.1	0.9	1.4	3.1	-
TP, TPD 50-60/4	0.1	0.1	0.2	0.9	1.5	3.2	-
TP, TPD 50-90/4	0.1	0.1	0.1	0.6	1.1	2.8	-
TP, TPD 50-80/4	0.1	0.1	0.1	0.8	1.3	3.0	-
TP, TPD 50-120/4	0.1	0.1	0.1	0.7	1.3	2.9	-
TP, TPD 50-140/4	0.1	0.1	0.1	0.7	1.3	2.9	-
TP, TPD 50-190/4	0.1	0.1	0.1	0.9	1.4	3.0	-
TP, TPD 50-230/4	0.1	0.1	0.2	1.0	1.5	3.1	-
TP, TPD 65-30/4	0.1	0.2	0.7	1.5	2.0	3.7	-
TP, TPD 65-60/4	0.2	0.4	0.9	1.6	2.2	3.9	-
TP, TPD 65-90/4	0.1	0.1	0.1	0.6	1.1	2.7	-
TP, TPD 65-110/4	0.1	0.1	0.1	0.6	1.1	2.7	-
TP, TPD 65-130/4	0.1	0.1	0.1	0.6	1.1	2.8	-
TP, TPD 65-150/4	0.1	0.1	0.1	0.6	1.2	2.8	-
TP, TPD 65-170/4	0.1	0.1	0.1	0.6	1.2	2.8	-
TP, TPD 65-240/4	0.1	0.1	0.1	0.8	1.3	2.9	-
TP, TPD 80-30/4	0.8	1.0	1.5	2.2	2.8	4.5	-
TP, TPD 80-60/4	0.8	1.0	1.5	2.3	2.8	4.5	-
TP, TPD 80-70/4	0.1	0.1	0.1	0.8	1.3	2.9	-

Pump type (50 Hz)	p [bar]						
	20 °C	60 °C	90 °C	110 °C	120 °C	140 °C	150 °C
TP, TPD 80-90/4	0.1	0.1	0.1	0.7	1.2	2.8	-
TP, TPD 80-110/4	0.1	0.1	0.1	0.8	1.4	3.0	-
TP, TPD 80-150/4	0.1	0.1	0.1	0.8	1.3	2.9	-
TP, TPD 80-170/4	0.1	0.1	0.2	1.0	1.5	3.1	-
TP, TPD 80-240/4	0.1	0.1	0.3	1.0	1.5	3.2	-
TP, TPD 80-270/4	0.1	0.1	0.2	0.9	1.5	3.1	-
TP, TPD 80-340/4	0.1	0.1	0.3	1.1	1.6	3.2	-
TP, TPD 100-30/4	0.8	1.0	1.5	2.2	2.8	4.5	-
TP, TPD 100-60/4	0.6	0.8	1.3	2.0	2.6	4.3	-
TP, TPD 100-70/4	0.1	0.1	0.1	0.8	1.3	3.0	-
TP, TPD 100-90/4	0.1	0.1	0.1	0.9	1.4	3.0	-
TP, TPD 100-110/4	0.1	0.1	0.2	1.0	1.5	3.1	-
TP, TPD 100-130/4	0.1	0.1	0.6	1.3	1.9	3.5	-
TP 100-140/4	0.2	0.4	0.8	1.8	2.3	3.9	5.2
TP, TPD 100-170/4	0.3	0.5	1.0	1.7	2.3	3.9	5.2
TP, TPD 100-200/4	0.1	0.1	0.5	1.2	1.8	3.4	4.7
TP, TPD 100-250/4	0.1	0.2	0.7	1.4	2.0	3.6	4.9
TP, TPD 100-330/4	0.3	0.5	1.0	1.7	2.3	3.9	5.2
TP, TPD 100-370/4	0.3	0.5	1.0	1.7	2.3	3.9	5.2
TP, TPD 100-410/4	0.5	0.7	1.2	1.9	2.5	4.1	5.4
TP 125-60/4	0.1	0.1	0.1	0.8	1.4	3.0	-
TP 125-80/4	0.1	0.1	0.1	0.9	1.4	3.1	-
TP 125-95/4	0.1	0.1	0.2	0.9	1.5	3.1	-
TP, TPD 125-110/4	0.1	0.1	0.1	0.9	1.4	3.0	-
TP, TPD 125-130/4	0.1	0.1	0.2	0.9	1.5	3.1	-
TP 125-150/4	0.2	0.4	0.8	1.8	2.3	3.9	5.2
TP, TPD 125-160/4	0.1	0.1	0.2	1.0	1.5	3.1	-
TP, TPD 125-190/4	0.1	0.1	0.2	0.9	1.5	3.1	4.4
TP, TPD 125-230/4	0.1	0.1	0.3	1.0	1.6	3.2	4.5
TP, TPD 125-300/4	0.1	0.1	0.2	0.9	1.5	3.1	4.4
TP, TPD 125-340/4	0.1	0.1	0.3	1.0	1.5	3.2	4.5
TP, TPD 125-400/4	0.1	0.1	0.3	1.0	1.6	3.2	4.5
TP 150-70/4	0.1	0.1	0.3	1.1	1.6	3.2	-
TP 150-110/4	0.1	0.1	0.4	1.1	1.7	3.3	-
TP 150-155/4	0.1	0.1	0.5	1.2	1.8	3.4	-
TP 150-170/4	0.1	0.1	0.6	1.3	1.9	3.5	-
TP, TPD 150-130/4	0.1	0.1	0.4	1.1	1.6	3.3	4.6
TP, TPD 150-160/4	0.1	0.1	0.4	1.1	1.7	3.3	4.6
TP, TPD 150-200/4	0.1	0.1	0.4	1.1	1.7	3.3	4.6
TP, TPD 150-220/4	0.1	0.1	0.5	1.2	1.8	3.4	4.7
TP, TPD 150-250/4	0.1	0.1	0.6	1.3	1.9	3.5	4.8

Pump type (50 Hz)	p [bar]						
	20 °C	60 °C	90 °C	110 °C	120 °C	140 °C	150 °C
TP 150-260/4	0.1	0.1	0.5	1.2	1.8	3.4	4.7
TP 150-280/4	0.1	0.3	0.8	1.5	2.1	3.7	5.0
TP 150-340/4	0.1	0.2	0.7	1.5	2.0	3.6	4.9
TP 150-390/4	0.1	0.2	0.7	1.4	2.0	3.6	4.9
TP 150-450/4	0.1	0.1	0.5	1.2	1.8	3.4	4.7
TP 150-520/4	0.1	0.1	1.0	1.5	1.9	3.5	4.8
TP 150-660/4	0.1	0.2	0.7	1.4	1.9	3.6	4.9
TP 150-680/4	0.1	0.2	0.7	1.4	2.0	3.6	-
TP 200-50/4	0.3	0.4	0.9	1.7	2.2	3.8	-
TP 200-70/4	0.1	0.3	0.8	1.5	2.1	3.7	-
TP 200-90/4	0.1	0.2	0.7	1.4	2.0	3.6	-
TP 200-130/4	0.1	0.1	0.5	1.2	1.8	3.4	-
TP 200-150/4	0.1	0.1	0.4	1.2	1.7	3.3	-
TP 200-160/4	0.3	0.5	1.0	1.7	2.3	3.9	5.2
TP 200-190/4	0.2	0.4	0.9	1.6	2.2	3.8	5.1
TP 200-200/4	0.2	0.4	0.9	1.6	2.1	3.8	5.1
TP 200-240/4	0.1	0.2	0.7	1.4	2.0	3.6	4.9
TP 200-270/4	0.1	0.1	0.4	1.1	1.7	3.3	4.6
TP 200-290/4	0.1	0.1	0.6	1.3	1.9	3.5	4.8
TP 200-320/4	0.1	0.1	0.5	1.2	1.8	3.4	4.7
TP 200-330/4	0.1	0.1	0.3	1.1	1.6	3.2	4.5
TP 200-360/4	0.1	0.1	0.3	1.1	1.6	3.2	4.5
TP 200-400/4	0.1	0.1	0.3	1.0	1.6	3.2	4.5
TP 200-410/4	0.1	0.2	0.7	1.4	1.9	3.6	4.9
TP 200-470/4	0.1	0.1	0.4	1.1	1.6	3.3	4.6
TP 200-530/4	0.1	0.1	0.4	1.1	1.7	3.3	4.6
TP 200-590/4	0.1	0.2	0.7	1.4	2.0	3.6	4.9
TP 200-660/4	0.2	0.4	0.9	1.7	2.2	3.8	5.1
TP 250-280/4	0.1	0.1	0.1	0.8	1.4	3.1	-
TP 250-310/4	0.1	0.1	0.1	0.8	1.4	3.1	-
TP 250-390/4	0.1	0.1	0.1	0.8	1.4	3.1	-
TP 300-190/4	0.5	0.7	1.1	2.1	2.6	4.2	5.5
TP 300-220/4	0.3	0.5	0.9	1.9	2.4	4	5.3
TP 300-250/4	0.1	0.3	0.7	1.7	2.2	3.8	5.1
TP 300-290/4	0.5	0.7	1.1	2.1	2.6	4.2	5.5
TP 300-390/4	0.5	0.7	1.1	2.1	2.6	4.2	5.5
TP 300-420/4	0.5	0.7	1.1	2.1	2.6	4.2	5.5
TP 300-430/4	0.5	0.7	1.1	2.1	2.6	4.2	5.5
TP 300-500/4	0.4	0.6	1	2	2.5	4.1	5.4
TP 300-550/4	0.3	0.5	0.9	1.9	2.4	4	5.3

Pump type (50 Hz)	p [bar]						
	20 °C	60 °C	90 °C	110 °C	120 °C	140 °C	150 °C
TP 350-230/4	2.0	2.2	2.6	3.6	4.1	5.7	7.0
TP 350-280/4	2.0	2.2	2.6	3.6	4.1	5.7	7.0
TP 350-310/4	2.0	2.2	2.6	3.6	4.1	5.7	7.0
TP 350-360/4	1.5	1.7	2.1	3.1	3.6	5.2	6.5
TP 350-420/4	1.4	1.6	2.0	3.0	3.5	5.1	6.4
TP 350-480/4	1.3	1.5	1.9	2.9	3.4	5.0	6.3
TP 350-530/4	0.5	0.7	1.1	2.1	2.6	4.2	5.5
TP 350-650/4	0.4	0.6	1.0	2.0	2.5	4.1	5.4
TP 350-780/4	0.3	0.5	0.9	1.9	2.4	4.0	5.3

**50 Hz, 6-pole**

Pump type (50 Hz)	p [bar]						
	20 °C	60 °C	90 °C	110 °C	120 °C	140 °C	150 °C
TP, TPD 125-60/6	0.1	0.1	0.1	0.7	1.2	2.8	-
TP, TPD 125-70/6	0.1	0.1	0.1	0.7	1.3	2.9	-
TP, TPD 125-80/6	0.1	0.1	0.1	0.7	1.2	2.9	-
TP, TPD 125-100/6	0.1	0.1	0.1	0.8	1.4	3.0	-
TP, TPD 125-130/6	0.1	0.1	0.1	0.7	1.3	2.9	-
TP, TPD 125-160/6	0.1	0.1	0.1	0.7	1.3	2.9	-
TP, TPD 150-60/6	0.1	0.1	0.1	0.7	1.3	2.9	-
TP, TPD 150-70/6	0.1	0.1	0.1	0.7	1.3	2.9	-
TP, TPD 150-90/6	0.1	0.1	0.1	0.8	1.3	2.9	-
TP, TPD 150-110/6	0.1	0.1	0.1	0.8	1.3	3.0	-

**60 Hz, 2-pole**

Pump type (60 Hz)	p [bar]						
	20 °C	60 °C	90 °C	110 °C	120 °C	140 °C	150 °C
TP 32-80/2	0.4	0.4	0.4	1.2	1.7	3.4	-
TP 32-160/2	0.4	0.6	1.1	1.9	2.4	4.1	-
TP 32-220/2	0.7	0.9	1.4	2.2	2.7	4.4	-
TP 32-260/2	0.7	0.9	1.4	2.2	2.7	4.4	-
TP 32-330/2	0.7	0.9	1.4	2.2	2.7	4.4	-
TP, TPD 32-300/2	0.1	0.1	0.1	0.7	1.2	2.8	-
TP, TPD 32-360/2	0.1	0.1	0.1	0.7	1.2	2.8	-
TP, TPD 32-450/2	0.1	0.1	0.1	0.7	1.2	2.8	-
TP, TPD 32-550/2	0.1	0.1	0.1	0.7	1.2	2.9	-
TP, TPD 32-680/2	0.1	0.1	0.2	0.9	1.5	3.1	-
TP, TPD 32-820/2	0.5	0.7	1.2	1.9	2.5	4.1	-
TP 40-80/2	0.1	0.3	0.8	1.6	2.1	3.8	-
TP 40-160/2	0.1	0.2	0.7	1.5	2.0	3.7	-
TP 40-240/2	0.4	0.6	1.1	1.9	2.4	4.1	-

Pump type (60 Hz)	p [bar]						
	20 °C	60 °C	90 °C	110 °C	120 °C	140 °C	150 °C
TP 40-270/2	0.7	0.9	1.4	2.2	2.7	4.4	-
TP 40-330/2	0.7	0.9	1.4	2.2	2.7	4.4	-
TP 40-390/2	0.7	0.9	1.4	2.2	2.7	4.4	-
TP, TPD 40-400/2	0.1	0.1	0.1	0.9	1.4	3.1	-
TP, TPD 40-460/2	0.1	0.1	0.3	1.0	1.6	3.2	-
TP, TPD 40-530/2	0.1	0.1	0.4	1.1	1.7	3.3	-
TP, TPD 40-690/2	0.1	0.2	0.7	1.4	2.0	3.6	-
TP, TPD 40-820/2	0.1	0.3	0.8	1.6	2.1	3.7	-
TP, TPD 40-920/2	0.4	0.6	1.1	1.8	2.4	4.0	-
TP 50-80/2	0.1	0.1	0.6	1.4	1.9	3.6	-
TP 50-160/2	0.4	0.6	1.1	1.9	2.4	4.1	-
TP 50-240/2	0.3	0.5	1.0	1.8	2.3	4.0	-
TP, TPD 50-250/2	0.1	0.1	0.2	1.0	1.5	3.1	-
TP, TPD 50-300/2	0.1	0.1	0.3	1.0	1.6	3.2	-
TP, TPD 50-350/2	0.1	0.1	0.3	1.0	1.6	3.2	-
TP, TPD 50-410/2	0.1	0.1	0.4	1.1	1.6	3.3	-
TP, TPD 50-430/2	0.1	0.1	0.4	1.1	1.7	3.3	-
TP, TPD 50-530/2	0.1	0.1	0.5	1.3	1.8	3.5	-
TP, TPD 50-640/2	0.1	0.1	0.6	1.4	1.9	3.5	-
TP, TPD 50-720/2	0.1	0.3	0.8	1.6	2.1	3.7	-
TP, TPD 50-790/2	0.5	0.7	1.2	1.9	2.5	4.1	-
TP, TPD 50-880/2	0.8	1.0	1.5	2.2	2.8	4.4	-
TP 50-1050/2	1.1	1.3	1.8	2.5	3.1	4.7	-
TP 65-80/2	0.6	0.8	1.3	2.1	2.6	4.3	-
TP 65-160/2	1.1	1.3	1.8	2.6	3.1	4.8	-
TP 65-240/2	0.9	1.1	1.6	2.4	2.9	4.6	-
TP, TPD 65-200/2	0.1	0.1	0.3	1.0	1.5	3.2	-
TP, TPD 65-250/2	0.1	0.1	0.4	1.1	1.7	3.3	-
TP, TPD 65-340/2	0.1	0.1	0.2	1.0	1.5	3.1	-
TP, TPD 65-390/2	0.1	0.1	0.3	1.0	1.5	3.2	-
TP, TPD 65-480/2	0.1	0.1	0.3	1.0	1.6	3.2	-
TP, TPD 65-540/2	0.1	0.1	0.3	1.1	1.6	3.2	-
TP, TPD 65-630/2	0.1	0.1	0.4	1.1	1.7	3.3	-
TP, TPD 65-740/2	0.1	0.1	0.6	1.3	1.9	3.5	-
TP, TPD 65-910/2	0.1	0.2	0.7	1.5	2.0	3.6	-
TP, TPD 65-920/2	0.1	0.2	0.7	1.4	2.0	3.6	-
TP, TPD 65-1050/2	0.1	0.2	0.7	1.5	2.0	3.6	-
TP 80-160/2	2.1	2.3	2.8	3.6	4.1	5.8	-
TP, TPD 80-200/2	0.5	0.7	1.2	1.9	2.5	4.1	-
TP, TPD 80-240/2	0.1	0.2	0.7	1.4	2.0	3.6	-
TP, TPD 80-290/2	0.1	0.3	0.8	1.5	2.1	3.7	-

Pump type (60 Hz)	p [bar]						
	20 °C	60 °C	90 °C	110 °C	120 °C	140 °C	150 °C
TP, TPD 80-330/2	0.2	0.4	0.9	1.7	2.2	3.8	-
TP, TPD 80-400/2	0.6	0.8	1.3	2.1	2.6	4.2	-
TP, TPD 80-480/2	0.1	0.3	0.8	1.5	2.1	3.7	-
TP, TPD 80-530/2	0.2	0.4	0.9	1.6	2.1	3.8	-
TP, TPD 80-640/2	0.6	0.8	1.3	2.0	2.6	4.2	-
TP, TPD 80-750/2	0.6	0.8	1.3	2.0	2.6	4.2	-
TP, TPD 100-230/2	0.4	0.6	1.1	1.9	2.4	4.0	-
TP, TPD 100-300/2	0.2	0.4	0.9	1.6	2.2	3.8	-
TP, TPD 100-370/2	0.3	0.5	1.0	1.7	2.3	3.9	-
TP, TPD 100-350/2	0.9	1.1	1.6	2.3	2.9	4.5	-
TP, TPD 100-380/2	1.2	1.4	1.9	2.6	3.2	4.8	-
TP, TPD 100-530/2	1.7	1.9	2.4	3.2	3.7	5.3	-
TP, TPD 100-630/2	1.4	1.6	2.1	2.8	3.3	5.0	-
TP, TPD 100-700/2	3.0	3.2	3.7	4.4	5.0	6.6	-
TP 100-760/2	1.7	1.9	2.3	3.3	3.8	5.4	6.7
TP 100-940/2	1.6	1.8	2.2	3.2	3.7	5.3	6.6
TP 100-1040/2	1.6	1.8	2.2	3.2	3.7	5.3	6.6
TP 100-1200/2	1.9	2.1	2.5	3.5	4	5.6	6.9
TP 100-1360/2	1.8	2	2.4	3.4	3.9	5.5	6.8
TP 100-1510/2	1.8	2	2.4	3.4	3.9	5.5	6.8

**60 Hz, 4-pole**

Pump type (60 Hz)	p [bar]						
	20 °C	60 °C	90 °C	110 °C	120 °C	140 °C	150 °C
TP 32-40/4	0.1	0.1	0.1	0.9	1.4	3.1	-
TP 32-80/4	0.1	0.1	0.5	1.3	1.8	3.5	-
TP, TPD 32-120/4	0.1	0.1	0.1	0.7	1.3	2.9	-
TP, TPD 32-140/4	0.1	0.1	0.1	0.7	1.3	2.9	-
TP, TPD 32-190/4	0.1	0.1	0.1	0.8	1.4	3.0	-
TP 40-40/4	0.1	0.1	0.3	1.1	1.6	3.3	-
TP 40-80/4	0.1	0.1	0.2	1.0	1.5	3.2	-
TP, TPD 40-110/4	0.1	0.1	0.1	0.6	1.2	2.8	-
TP, TPD 40-150/4	0.1	0.1	0.1	0.7	1.3	2.9	-
TP, TPD 40-180/4	0.1	0.1	0.1	0.7	1.3	2.9	-
TP, TPD 40-230/4	0.1	0.1	0.1	0.8	1.3	3.0	-
TP 50-40/4	0.1	0.1	0.3	1.1	1.6	3.3	-
TP 50-80/4	0.1	0.1	0.3	1.1	1.6	3.3	-
TP, TPD 50-100/4	0.1	0.1	0.1	0.7	1.3	2.9	-
TP, TPD 50-115/4	0.1	0.1	0.1	0.8	1.4	3.0	-
TP, TPD 50-130/4	0.1	0.1	0.1	0.9	1.4	3.0	-
TP, TPD 50-180/4	0.1	0.1	0.1	0.8	1.3	3.0	-



Pump type (60 Hz)	p [bar]						
	20 °C	60 °C	90 °C	110 °C	120 °C	140 °C	150 °C
TP, TPD 50-240/4	0.1	0.1	0.2	0.9	1.5	3.1	-
TP, TPD 50-270/4	0.1	0.1	0.3	1.0	1.6	3.2	-
TP, TPD 50-340/4	0.1	0.2	0.7	1.4	2.0	3.6	-
TP 65-40/4	0.4	0.6	1.1	1.9	2.4	4.1	-
TP 65-80/4	0.7	0.9	1.4	2.2	2.7	4.4	-
TP, TPD 65-130/4	0.1	0.1	0.1	0.6	1.2	2.8	-
TP, TPD 65-150/4	0.1	0.1	0.1	0.6	1.2	2.8	-
TP, TPD 65-190/4	0.1	0.1	0.1	0.6	1.2	2.8	-
TP, TPD 65-230/4	0.1	0.1	0.1	0.7	1.3	2.9	-
TP, TPD 65-310/4	0.1	0.1	0.1	0.7	1.3	2.9	-
TP, TPD 65-330/4	0.1	0.1	0.1	0.3	0.8	2.5	-
TP 80-40/4	1.5	1.7	2.2	3.0	3.5	5.2	-
TP 80-80/4	1.6	1.8	2.3	3.1	3.6	5.3	-
TP, TPD 80-110/4	0.1	0.1	0.1	0.8	1.4	3.0	-
TP, TPD 80-150/4	0.1	0.1	0.1	0.8	1.3	2.9	-
TP, TPD 80-170/4	0.1	0.1	0.1	0.8	1.3	3.0	-
TP, TPD 80-230/4	0.1	0.1	0.3	1.0	1.6	3.2	-
TP, TPD 80-280/4	0.1	0.1	0.2	1.0	1.5	3.1	-
TP, TPD 80-340/4	0.1	0.1	0.3	1.0	1.6	3.2	-
TP, TPD 80-410/4	0.1	0.1	0.5	1.2	1.8	3.4	-
TP, TPD 80-460/4	0.1	0.1	0.6	1.3	1.9	3.5	-
TP, TPD 80-510/4	0.1	0.2	0.7	1.5	2.0	3.6	-
TP 100-40/4	1.4	1.6	2.1	2.9	3.4	5.1	-
TP 100-80/4	1.2	1.4	1.9	2.7	3.2	4.9	-
TP, TPD 100-100/4	0.1	0.1	0.2	0.9	1.5	3.1	-
TP, TPD 100-130/4	0.1	0.1	0.3	1.0	1.6	3.2	-
TP, TPD 100-150/4	0.1	0.1	0.6	1.3	1.9	3.5	-
TP, TPD 100-170/4	0.1	0.1	0.6	1.3	1.9	3.5	-
TP, TPD 100-200/4	0.1	0.1	0.4	1.1	1.7	3.3	4.6
TP, TPD 100-240/4	0.1	0.1	0.6	1.3	1.9	3.5	4.8
TP, TPD 100-260/4	0.6	0.8	1.3	2.1	2.7	4.3	5.6
TP, TPD 100-290/4	0.5	0.7	1.2	2.0	2.5	4.1	5.4
TP, TPD 100-340/4	0.6	0.8	1.3	2.0	2.6	4.2	5.5
TP, TPD 100-350/4	0.2	0.4	0.9	1.7	2.3	3.9	5.2
TP, TPD 100-390/4	0.7	0.9	1.4	2.1	2.7	4.3	5.6
TP, TPD 100-470/4	0.9	1.1	1.6	2.3	2.9	4.5	5.8
TP 100-560/4	0.1	0.3	0.7	1.7	2.2	3.8	5.1
TP 125-80/4	0.1	0.1	0.1	0.8	1.4	3.0	-
TP 125-110/4	0.1	0.1	0.2	0.9	1.5	3.1	-
TP 125-135/4	0.1	0.1	0.3	1.1	1.6	3.3	-
TP, TPD 125-130/4	0.1	0.1	0.3	1.0	1.6	3.2	-









Pump type (60 Hz)	p [bar]						
	20 °C	60 °C	90 °C	110 °C	120 °C	140 °C	150 °C
TP, TPD 125-160/4	0.1	0.1	0.3	1.1	1.6	3.2	-
TP, TPD 125-200/4	0.1	0.1	0.2	0.9	1.4	3.1	-
TP, TPD 125-230/4	0.1	0.1	0.4	1.1	1.7	3.3	-
TP 125-220/4	0.1	0.1	0.4	1.1	1.7	3.3	4.5
TP, TPD 125-280/4	0.1	0.1	0.4	1.1	1.7	3.3	4.5
TP, TPD 125-340/4	0.1	0.1	0.5	1.2	1.8	3.4	4.6
TP, TPD 125-365/4	0.3	0.5	1.0	1.7	2.3	3.9	5.2
TP, TPD 125-420/4	0.1	0.1	0.3	1.0	1.6	3.2	4.5
TP, TPD 125-480/4	0.1	0.1	0.5	1.2	1.8	3.4	4.7
TP 125-550/4	0.1	0.3	0.7	1.7	2.2	3.8	5.1
TP 125-580/4	0.1	0.3	0.7	1.7	2.2	3.8	5.1
TP 150-130/4	0.1	0.1	0.5	1.2	1.8	3.4	-
TP 150-160/4	0.1	0.2	0.7	1.5	2.0	3.6	-
TP 150-200/4	0.2	0.4	0.9	1.6	2.1	3.8	-
TP 150-220/4	0.3	0.5	1.0	1.7	2.3	3.9	-
TP, TPD 150-180/4	0.1	0.2	0.7	1.4	1.9	3.6	4.9
TP, TPD 150-210/4	0.1	0.2	0.7	1.4	2.0	3.6	4.9
TP, TPD 150-240/4	0.1	0.2	0.7	1.5	2.0	3.6	4.9
TP, TPD 150-300/4	0.1	0.3	0.8	1.5	2.1	3.7	5.0
TP, TPD 150-340/4	0.1	0.3	0.8	1.5	2.1	3.7	5.0
TP 150-360/4	0.3	0.5	1.0	1.8	2.3	4.0	5.3
TP 150-400/4	0.1	0.1	0.1	0.8	1.4	3.1	4.4
TP 150-440/4	0.1	0.1	0.4	1.1	1.7	3.3	4.6
TP 150-480/4	0.1	0.1	0.5	1.3	1.8	3.4	4.7
TP 150-610/4	0.1	0.2	0.7	1.4	2	3.6	4.9
TP 150-700/4	0.1	0.3	0.8	1.5	2.1	3.7	5.0
TP 150-810/4	0.3	0.4	0.9	1.7	2.2	3.8	5.1
TP 150-960/4	0.4	0.6	1.1	1.8	2.3	3.8	5.1
TP 200-80/4	0.9	1.1	1.6	2.3	2.9	4.5	-
TP 200-110/4	0.5	0.6	1.1	1.9	2.4	4.0	-
TP 200-140/4	0.3	0.5	1	1.7	2.3	3.9	-
TP 200-190/4	0.2	0.4	0.9	1.6	2.2	3.8	-
TP 200-210/4	0.1	0.2	0.7	1.4	2	3.6	-
TP 200-250/4	0.9	1.0	1.5	2.3	2.8	4.4	5.7
TP 200-280/4	0.7	0.9	1.4	2.1	2.7	4.3	5.6
TP 200-320/4	0.6	0.8	1.3	2.0	2.6	4.2	5.5
TP 200-360/4	0.4	0.6	1.1	1.8	2.4	4.0	5.3
TP 200-390/4	0.3	0.5	1.0	1.7	2.2	3.9	5.2
TP 200-400/4	0.1	0.1	0.6	1.3	1.9	3.6	4.9
TP 200-430/4	0.1	0.1	0.6	1.4	1.9	3.6	4.9
TP 200-440/4	0.1	0.2	0.7	1.5	2.0	3.7	5.0









Pump type (60 Hz)	p [bar]						
	20 °C	60 °C	90 °C	110 °C	120 °C	140 °C	150 °C
TP 200-490/4	0.1	0.1	0.1	0.8	1.4	3.1	4.4
TP 200-500/4	0.2	0.4	0.9	1.6	2.2	3.9	5.2
TP 200-540/4	0.1	0.1	0.1	0.8	1.4	3.1	4.4
TP 200-600/4	0.1	0.1	0.1	0.8	1.4	3.1	4.4
TP 200-680/4	0.1	0.1	0.1	0.8	1.4	3.1	4.4
TP 200-770/4	0.1	0.2	0.7	1.4	2.0	3.7	5.0
TP 250-450/4	1.5	1.7	2.2	2.9	3.5	5.2	-
TP 250-530/4	1.5	1.7	2.2	2.9	3.5	5.2	-
TP 250-580/4	1.4	1.6	2.1	2.9	3.4	5.1	-
TP 300-230/4	0.8	1.0	1.4	2.4	2.9	4.5	5.8
TP 300-270/4	0.7	0.9	1.3	2.3	2.8	4.4	5.7
TP 300-360/4	0.7	0.9	1.3	2.3	2.8	4.4	5.7
TP 300-370/4	0.8	1.0	1.4	2.4	2.9	4.5	5.8
TP 300-440/4	0.8	1.0	1.4	2.4	2.9	4.5	5.8
TP 300-550/4	0.8	1.0	1.4	2.4	2.9	4.5	5.8
TP 300-630/4	0.8	1.0	1.4	2.4	2.9	4.5	5.8
TP 300-640/4	0.7	0.9	1.3	2.3	2.8	4.4	5.7
TP 300-750/4	0.7	0.9	1.3	2.3	2.8	4.4	5.7
TP 350-280/4	2.0	2.2	2.6	3.6	4.1	5.7	7.0
TP 350-330/4	1.9	2.1	2.5	3.5	4.0	5.6	6.9
TP 350-390/4	1.9	2.1	2.5	3.5	4.0	5.6	6.9
TP 350-440/4	1.9	2.1	2.5	3.5	4.0	5.6	6.9
TP 350-450/4	2.0	2.2	2.6	3.6	4.1	5.7	7.0
TP 350-540/4	2.0	2.2	2.6	3.6	4.1	5.7	7.0
TP 350-680/4	2.0	2.2	2.6	3.6	4.1	5.7	7.0









## Maximum sound pressure level

Three-phase motors [kW]	50 Hz [dB(A)]			60 Hz [dB(A)]	
	2-pole	4-pole	6-pole	2-pole	4-pole
0.12	< 70	< 70	-	< 70	< 70
0.18	< 70	< 70	-	< 70	< 70
0.25	56	41	-	< 70	45
0.37	56	45	-	57	45
0.55	57	42	-	56	45
0.75	53	59.5	-	57	49
1.1	53	49.5	-	58	53
1.5	58	50	47	64	53
2.2	60	51	52	65	55
3.0	59.5	53	63	53.5	55
4.0	63	54	63	67.5	57
5.5	62	50	63	68	62
7.5	60	51	66	65	62
11.0	60	53	-	64.5	66
15.0	60	66	-	65	66
18.5	60.5	63	-	65.5	63
22.0	65.5	63	-	70.5	63
30.0	70	65	-	75	65
37.0	71	66	-	75	65
45.0	67	66	-	75	65
55.0	72	67	-	75	68
75.0	74	70	-	77	71
90.0	73	70	-	77	71
110.0	76	70	-	81	75
132.0	76	70	-	81	75
160.0	76	70	-	81	75
200.0	-	70	-	81	75
250.0	-	73	-	86	77
315.0	-	73	-	-	77
355.0	-	75	-	-	-
400.0	-	75	-	-	-
500.0	-	75	-	-	-
560.0	-	78	-	-	-
630.0	-	78	-	-	-

TP, TPE pumps from 11 kW and up suspended in the pipes

Pump type	PN 16	PN 25	P2 [kW]								
<b>50 Hz</b>											
TP, TPE 65-460/2	●	-	11		-					●	
TP, TPE 65-550/2	●	-	15		-					●	
TP, TPE 65-660/2	●	-	18.5		-					●	
TP, TPE 65-720/2	●	-	22		-					●	
TP, TPE 80-330/2	●	-	11		-					●	
TP, TPE 80-400/2	●	-	15		-					●	
TP, TPE 80-520/2	●	-	18.5		-					●	
TP, TPE 80-570/2	●	-	22		-					●	
TP, TPE 100-250/2	●	-	11		-					●	
TP, TPE 100-310/2	●	-	15		-					●	
TP, TPE 100-360/2	●	-	18.5		-					●	
TP, TPE 100-390/2	●	-	22		-					●	
TP, TPE 80-340/4	●	-	11		-					●	
TP, TPE 100-250/4	●	●	11		-					●	
TP, TPE 100-330/4	●	●	15		-					●	
TP, TPE 100-370/4	●	●	18.5		-					●	
TP 100-410/4	●	●	22		-					●	
TP, TPE 125-190/4	●	●	11		-					●	
TP, TPE 125-230/4	●	●	15		-					●	
TP, TPE 125-300/4	●	●	18.5		-					●	
TP 125-340/4	●	●	22		-					●	
TP, TPE 150-200/4	●	●	15		-					●	
TP, TPE 150-220/4	●	●	18.5		-					●	
TP 150-250/4	●	●	22		-					●	
TP, TPE 150-260/4	-	●	18.5		●					-	
TP 150-280/4	-	●	22		●					-	
TP 150-340/4	-	●	30		●					-	
TP 150-390/4	-	●	37		●					-	
TP 150-450/4	-	●	45		●					-	
TP 150-520/4	-	●	55		●					-	
TP 150-660/4	-	●	75		●					-	
TP, TPE 200-160/4	-	●	15		●					-	
TP, TPE 200-190/4	-	●	18.5		●					-	
TP 200-200/4	-	●	22		●					-	
TP 200-240/4	-	●	30		●					-	
TP 200-270/4	-	●	45		●					-	
TP 200-320/4	-	●	55		●					-	
TP 200-330/4	-	●	37		●					-	
TP 200-360/4	-	●	45		●					-	
TP 200-400/4	-	●	55		●					-	
TP 200-410/4	-	●	75		●					-	
TP 200-470/4	-	●	75		●					-	

Pump type	PN 16	PN 25	P2 [kW]								
TP 300-190/4	-	●	30		●					-	
TP 300-220/4	-	●	37		●					-	
TP 300-250/4	-	●	45		●					-	
TP 300-290/4	-	●	55		●					-	
TP 300-390/4	-	●	75		●					-	
TP 300-420/4	-	●	90		●					-	
TP 300-430/4	-	●	110		●					-	
TP 300-500/4	-	●	132		●					-	
TP 300-550/4	-	●	160		●					-	
TP 350-230/4	-	●	55		●					-	
TP 350-280/4	-	●	75		●					-	
TP 350-310/4	-	●	90		●					-	
TP 350-360/4	-	●	110		●					-	
TP 350-420/4	-	●	132		●					-	
TP 350-480/4	-	●	160		●					-	
TP 350-530/4	-	●	200		●					-	
TP 350-650/4	-	●	250		●					-	
TP 350-780/4	-	●	315		●					-	
<b>60 Hz</b>											
TP, TPE 65-480/2	●	-	11		-					●	
TP, TPE 65-540/2	●	-	15		-					●	
TP, TPE 65-630/2	●	-	18.5		-					●	
TP, TPE 65-740/2	●	-	22		-					●	
TP, TPE 80-330/2	●	-	11		-					●	
TP, TPE 80-400/2	●	-	15		-					●	
TP, TPE 80-480/2	●	-	18.5		-					●	
TP, TPE 80-530/2	●	-	22		-					●	
TP, TPE 100-300/2	●	-	11		-					●	
TP, TPE 100-370/2	●	-	15		-					●	
TP, TPE 100-350/2	●	-	18.5		-					●	
TP, TPE 100-380/2	●	-	22		-					●	
TP, TPE 80-340/4	●	-	11		-					●	
TP, TPE 80-410/4	●	-	15		-					●	
TP, TPE 80-460/4	●	-	18.5		-					●	
TP 80-510/4	●	-	22		-					●	
TP, TPE 100-240/4	●	●	11		●					●	
TP, TPE 100-260/4	●	-	11		-					●	
TP, TPE 100-290/4	●	●	15		●					●	
TP, TPE 100-340/4	●	●	18.5		●					●	
TP 100-350/4	●	-	22		-					●	
TP 100-390/4	●	●	22		●					●	
TP 100-470/4	-	●	30		●					-	
TP 100-560/4	-	●	37		●					-	
TP, TPE 125-200/4	●	-	11		-					●	

Pump type	PN 16	PN 25	P2 [kW]								
TP, TPE 125-230/4	●	-	15							●	
TP, TPE 125-220/4	-	●	15							●	
TP, TPE 125-280/4	●	●	18.5							●	
TP 125-340/4	●	●	22							●	
TP 125-365/4	-	●	30			●				-	
TP 125-420/4	-	●	30			●				-	
TP 125-480/4	-	●	37			●				-	
TP 125-550/4	-	●	45			●				-	
TP 125-580/4	-	●	55			●				-	
TP, TPE 150-180/4	●	●	15							●	
TP, TPE 150-210/4	●	●	18.5							●	
TP 150-240/4	●	●	22							●	
TP 150-300/4	-	●	30			●				-	
TP 150-340/4	-	●	37			●				-	
TP 150-360/4	-	●	30			●				-	
TP 150-400/4	-	●	37			●				-	
TP 150-440/4	-	●	45			●				-	
TP 150-480/4	-	●	55			●				-	
TP 150-610/4	-	●	75			●				-	
TP 150-810/4	-	●	110			●				-	
TP 150-960/4	-	●	132			●				-	
TP 200-250/4	-	●	30			●				-	
TP 200-400/4	-	●	75			●				-	
TP 200-430/4	-	●	55			●				-	
TP 300-230/4	-	●	45			●				-	
TP 300-270/4	-	●	55			●				-	
TP 300-360/4	-	●	75			●				-	
TP 300-370/4	-	●	90			●				-	
TP 300-440/4	-	●	110			●				-	
TP 300-550/4	-	●	132			●				-	
TP 300-630/4	-	●	160			●				-	
TP 300-640/4	-	●	200			●				-	
TP 300-750/4	-	●	250			●				-	
TP 350-280/4	-	●	90			●				-	
TP 350-330/4	-	●	110			●				-	
TP 350-390/4	-	●	132			●				-	
TP 350-440/4	-	●	160			●				-	
TP 350-450/4	-	●	160			●				-	
TP 350-540/4	-	●	200			●				-	
TP 350-680/4	-	●	250			●				-	

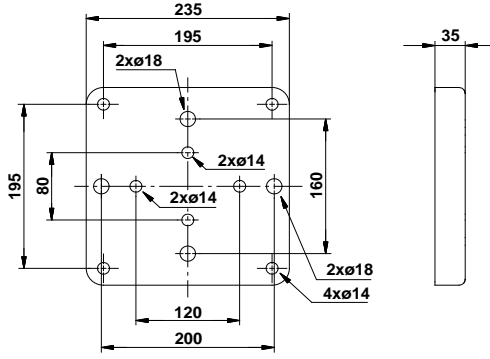

Fig. 1

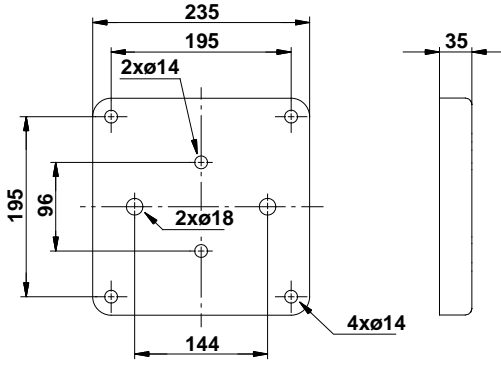

Fig. 2

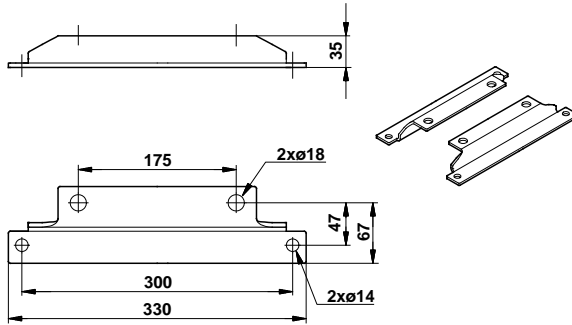

Fig. 3

TM00 9835 0497

TM00 3755 5097

TM02 5336 2602





**Argentina**

Bombas GRUNDFOS de Argentina S.A.  
Ruta Panamericana km. 37.500 Centro  
Industrial Garin  
1619 Garin Pcia. de B.A.  
Phone: +54-3327 414 444  
Telefax: +54-3327 45 3190

**Australia**

GRUNDFOS Pumps Pty. Ltd.  
P.O. Box 2040  
Regency Park  
South Australia 5942  
Phone: +61-8-8461-4611  
Telefax: +61-8-8340 0155

**Austria**

GRUNDFOS Pumpen Vertrieb  
Ges.m.b.H.  
Grundfosstraße 2  
A-5082 Grödig/Salzburg  
Tel.: +43-6246-883-0  
Telefax: +43-6246-883-30

**Belgium**

N.V. GRUNDFOS Bellux S.A.  
Boomsesteenweg 81-83  
B-2630 Aartselaar  
Tél.: +32-3-870 7300  
Télécopie: +32-3-870 7301

**Belarus**

Представительство ГРУНДФОС в  
Минске  
220125, Минск  
ул. Шафарнянская, 11, оф. 56, БЦ  
«Порт»  
Тел.: +7 (375 17) 286 39 72/73  
Факс: +7 (375 17) 286 39 71  
E-mail: minsk@grundfos.com

**Bosna and Herzegovina**

GRUNDFOS Sarajevo  
Zmaja od Bosne 7-7A,  
BH-71000 Sarajevo  
Phone: +387 33 592 480  
Telefax: +387 33 590 465  
www.ba.grundfos.com  
e-mail: grundfos@bih.net.ba

**Brazil**

BOMBAS GRUNDFOS DO BRASIL  
Av. Humberto de Alencar Castelo  
Branco, 630  
CEP 09850 - 300  
São Bernardo do Campo - SP  
Phone: +55-11 4393 5533  
Telefax: +55-11 4343 5015

**Bulgaria**

Grundfos Bulgaria EOOD  
Slatina District  
Iztochna Tangenta street no. 100  
BG - 1592 Sofia  
Tel. +359 2 49 22 200  
Fax. +359 2 49 22 201  
email: bulgaria@grundfos.bg

**Canada**

GRUNDFOS Canada Inc.  
2941 Brighton Road  
Oakville, Ontario  
L6H 6C9  
Phone: +1-905 829 9533  
Telefax: +1-905 829 9512

**China**

GRUNDFOS Pumps (Shanghai) Co. Ltd.  
10F The Hub, No. 33 Suhong Road  
Minhang District  
Shanghai 201106  
PRC  
Phone: +86 21 612 252 22  
Telefax: +86 21 612 253 33

**Croatia**

GRUNDFOS CROATIA d.o.o.  
Buzinski prilaz 38, Buzin  
HR-10010 Zagreb  
Phone: +385 1 6595 400  
Telefax: +385 1 6595 499  
www.hr.grundfos.com

**Czech Republic**

GRUNDFOS s.r.o.  
Čajkovského 21  
779 00 Olomouc  
Phone: +420-585-716 111  
Telefax: +420-585-716 299

**Denmark**

GRUNDFOS DK A/S  
Martin Bachs Vej 3  
DK-8850 Bjerringbro  
Tlf.: +45-87 50 50 50  
Telefax: +45-87 50 51 51  
E-mail: info\_GDK@grundfos.com  
www.grundfos.com/DK

**Estonia**

GRUNDFOS Pumps Eesti OÜ  
Peterburi tee 92G  
11415 Tallinn  
Tel: + 372 606 1690  
Fax: + 372 606 1691

**Finland**

OY GRUNDFOS Pumput AB  
Trukkikuja 1  
FI-01360 Vantaa  
Phone: +358-(0) 207 889 500  
Telefax: +358-(0) 207 889 550

**France**

Pompes GRUNDFOS Distribution S.A.  
Parc d'Activités de Chesnes  
57, rue de Malacombe  
F-38290 St. Quentin Fallavier (Lyon)  
Tél.: +33-4 74 82 15 15  
Télécopie: +33-4 74 94 10 51

**Germany**

GRUNDFOS GMBH  
Schlüterstr. 33  
40699 Erkrath  
Tel.: +49-(0) 211 929 69-0  
Telefax: +49-(0) 211 929 69-3799  
e-mail: infoservice@grundfos.de  
Service in Deutschland:  
e-mail: kundendienst@grundfos.de

**Greece**

GRUNDFOS Hellas A.E.B.E.  
20th km. Athinon-Markopoulou Av.  
P.O. Box 71  
GR-19002 Peania  
Phone: +0030-210-66 83 400  
Telefax: +0030-210-66 46 273

**Hong Kong**

GRUNDFOS Pumps (Hong Kong) Ltd.  
Unit 1, Ground floor  
Siu Wai Industrial Centre  
29-33 Wing Hong Street &  
68 King Lam Street, Cheung Sha Wan  
Kowloon  
Phone: +852-27861706 / 27861741  
Telefax: +852-27858664

**Hungary**

GRUNDFOS Hungária Kft.  
Park u. 8  
H-2045 Törökbálint,  
Phone: +36-23 511 110  
Telefax: +36-23 511 111

**India**

GRUNDFOS Pumps India Private  
Limited  
118 Old Mahabalipuram Road  
Thoraipakkam  
Chennai 600 096  
Phone: +91-44 2496 6800

**Indonesia**

PT. GRUNDFOS POMPA  
Graha Intirub Lt. 2 & 3  
Jln. Ciliitan Besar No.454. Makasar,  
Jakarta Timur  
ID-Jakarta 13650  
Phone: +62 21-469-51900  
Telefax: +62 21-460 6910 / 460 6901

**Ireland**

GRUNDFOS (Ireland) Ltd.  
Unit A, Merrymell Business Park  
Ballymount Road Lower  
Dublin 12  
Phone: +353-1-4089 800  
Telefax: +353-1-4089 830

**Italy**

GRUNDFOS Pompe Italia S.r.l.  
Via Gran Sasso 4  
I-20060 Truccazzano (Milano)  
Tel.: +39-02-95838112  
Telefax: +39-02-95309290 / 95838461

**Japan**

GRUNDFOS Pumps K.K.  
1-2-3, Shin-Miyakoda, Kita-ku,  
Hamamatsu  
431-2103 Japan  
Phone: +81 53 428 4760  
Telefax: +81 53 428 5005

**Korea**

GRUNDFOS Pumps Korea Ltd.  
6th Floor, Aju Building 679-5  
Yeoksam-dong, Kangnam-ku, 135-916  
Seoul, Korea  
Phone: +82-2-5317 600  
Telefax: +82-2-5633 725

**Latvia**

SIA GRUNDFOS Pumps Latvia  
Deglava biznesa centrs  
Augusta Deglava iela 60, LV-1035, Rīga,  
Tālr.: + 371 714 9640, 7 149 641  
Faks: + 371 914 9646

**Lithuania**

GRUNDFOS Pumps UAB  
Smolensko g. 6  
LT-03201 Vilnius  
Tel: + 370 52 395 430  
Fax: + 370 52 395 431

**Malaysia**

GRUNDFOS Pumps Sdn. Bhd.  
7 Jalan Peguam U1/25  
Glenmarie Industrial Park  
40150 Shah Alam  
Selangor  
Phone: +60-3-5569 2922  
Telefax: +60-3-5569 2866

**Mexico**

Bombas GRUNDFOS de México S.A. de  
C.V.  
Boulevard TLC No. 15  
Parque Industrial Stiva Aeropuerto  
Apodaca, N.L. 66600  
Phone: +52-81-8144 4000  
Telefax: +52-81-8144 4010

**Netherlands**

GRUNDFOS Netherlands  
Veluwezoom 35  
1326 AE Almere  
Postbus 22015  
1302 CA ALMERE  
Tel.: +31-88-478 6336  
Telefax: +31-88-478 6332  
E-mail: info\_gnl@grundfos.com

**New Zealand**

GRUNDFOS Pumps NZ Ltd.  
17 Beatrice Tinsley Crescent  
North Harbour Industrial Estate  
Albany, Auckland  
Phone: +64-9-415 3240  
Telefax: +64-9-415 3250

**Norway**

GRUNDFOS Pumper A/S  
Strømsveien 344  
Postboks 235, Leirdal  
N-1011 Oslo  
Tlf.: +47-22 90 47 00  
Telefax: +47-22 32 21 50

**Poland**

GRUNDFOS Pompy Sp. z o.o.  
ul. Klonowa 23  
Baranowo k. Poznania  
PL-62-081 Przeźmierowo  
Tel: (+48-61) 650 13 00  
Fax: (+48-61) 650 13 50

**Portugal**

Bombas GRUNDFOS Portugal, S.A.  
Rua Calvet de Magalhães, 241  
Apartado 1079  
P-2770-153 Paço de Arcos  
Tel.: +351-21-440 76 00  
Telefax: +351-21-440 76 90

**Romania**

GRUNDFOS Pompe România SRL  
Bd. Biruintei, nr 103  
Pantelimon county Ilfov  
Phone: +40 21 200 4100  
Telefax: +40 21 200 4101  
E-mail: romania@grundfos.ro

**Russia**

ООО Грундфос Россия  
109544, г. Москва, ул. Школьная,  
39-41, стр. 1  
Тел. (+7) 495 564-88-00 (495)  
737-30-00  
Факс (+7) 495 564 88 11  
E-mail grundfos.moscow@grundfos.com

**Serbia**

Grundfos Srbija d.o.o.  
Omladinskih brigada 90b  
11070 Novi Beograd  
Phone: +381 11 2258 740  
Telefax: +381 11 2281 769  
www.rs.grundfos.com

**Singapore**

GRUNDFOS (Singapore) Pte. Ltd.  
25 Jalan Tukang  
Singapore 619264  
Phone: +65-6681 9688  
Telefax: +65-6681 9689

**Slovakia**

GRUNDFOS s.r.o.  
Prievozská 4D  
821 09 BRATISLAVA  
Phona: +421 2 5020 1426  
sk.grundfos.com

**Slovenia**

GRUNDFOS LJUBLJANA, d.o.o.  
Leskovoška 9e, 1122 Ljubljana  
Phone: +386 (0) 1 568 06 10  
Telefax: +386 (0) 1 568 06 19  
E-mail: tehnika-si@grundfos.com

**South Africa**

GRUNDFOS (PTY) LTD  
Corner Mountjoy and George Allen  
Roads  
Wilbart Ext. 2  
Bedfordview 2008  
Phone: (+27) 11 579 4800  
Fax: (+27) 11 455 6066  
E-mail: lsmart@grundfos.com

**Spain**

Bombas GRUNDFOS España S.A.  
Camino de la Fuentequilla, s/n  
E-28110 Algete (Madrid)  
Tel.: +34-91-848 8800  
Telefax: +34-91-628 0465

**Sweden**

GRUNDFOS AB  
Box 333 (Lunnagårdsgatan 6)  
431 24 Mölndal  
Tel.: +46 31 332 23 000  
Telefax: +46 31 331 94 60

**Switzerland**

GRUNDFOS Pumpen AG  
Bruggacherstrasse 10  
CH-8117 Fällanden/ZH  
Tel.: +41-44-806 8111  
Telefax: +41-44-806 8115

**Taiwan**

GRUNDFOS Pumps (Taiwan) Ltd.  
7 Floor, 219 Min-Chuan Road  
Taichung, Taiwan, R.O.C.  
Phone: +886-4-2305 0868  
Telefax: +886-4-2305 0878

**Thailand**

GRUNDFOS (Thailand) Ltd.  
92 Chaloev Phrakiat Rama 9 Road,  
Dokmai, Pravej, Bangkok 10250  
Phone: +66-2-725 8999  
Telefax: +66-2-725 8998

**Turkey**

GRUNDFOS POMPA San. ve Tic. Ltd.  
Sti.  
Gebze Organize Sanayi Bölgesi  
İhsan dede Caddesi,  
2. yol 200. Sokak No. 204  
41490 Gebze/ Kocaeli  
Phone: +90 - 262-679 7979  
Telefax: +90 - 262-679 7905  
E-mail: satis@grundfos.com

**Ukraine**

Бізнес Центр Європа  
Столичне шосе, 103  
м. Київ, 03131, Україна  
Телефон: (+38 044) 237 04 00  
Факс.: (+38 044) 237 04 01  
E-mail: ukraine@grundfos.com

**United Arab Emirates**

GRUNDFOS Gulf Distribution  
P.O. Box 16768  
Jebel Ali Free Zone  
Dubai  
Phone: +971 4 8815 166  
Telefax: +971 4 8815 136

**United Kingdom**

GRUNDFOS Pumps Ltd.  
Grovebury Road  
Leighton Buzzard/Beds. LU7 4TL  
Phone: +44-1525-850000  
Telefax: +44-1525-850011

**U.S.A.**

GRUNDFOS Pumps Corporation  
17100 West 118th Terrace  
Olathe, Kansas 66061  
Phone: +1-913-227-3400  
Telefax: +1-913-227-3500

**Uzbekistan**

Grundfos Tashkent, Uzbekistan The Rep-  
resentative Office of Uzbekistan Kazakhstan  
in Uzbekistan  
38a, Oybek street, Tashkent  
Телефон: (+998) 71 150 3290 / 71 150  
3291  
Факс: (+998) 71 150 3292

Addresses Revised 01.07.2016

be think innovate

---

**96404999** 0516

ECM: 1183385

The name Grundfos, the Grundfos logo, and **be think innovate** are registered trademarks owned by Grundfos Holding A/S or Grundfos A/S, Denmark. All rights reserved worldwide.  
© Copyright Grundfos Holding A/S

[www.grundfos.com](http://www.grundfos.com)

**GRUNDFOS** 